

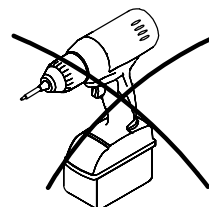

BARLOW

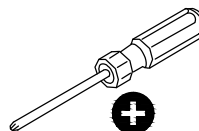

			✓
①	1	1050 x 490 x 55	
②	1	740 x 490 x 55	
③	1	335 x 60 x 19	
④	1	335 x 60 x 19	
⑤	2	390 x Ø19	
⑥	1	395 x 435 x 15	

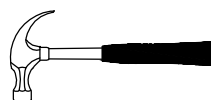
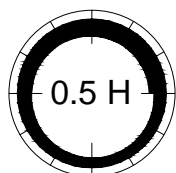
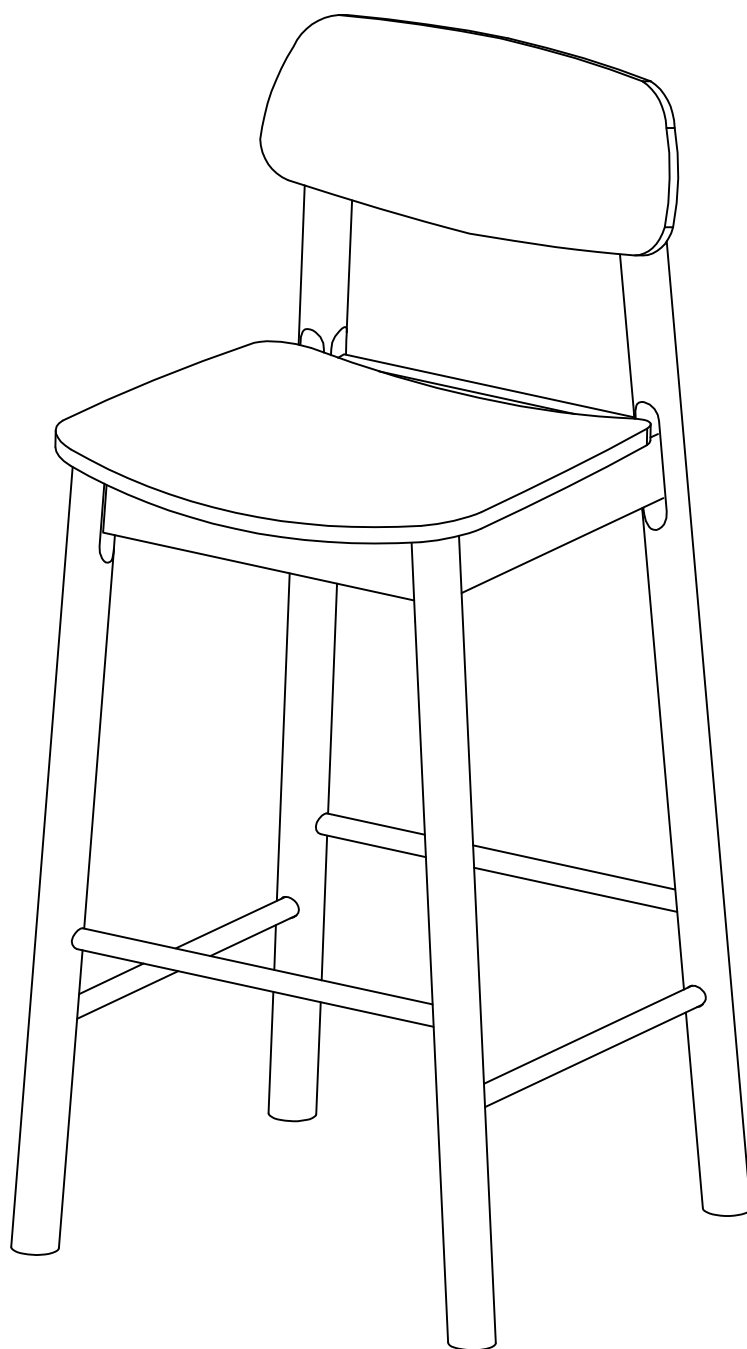
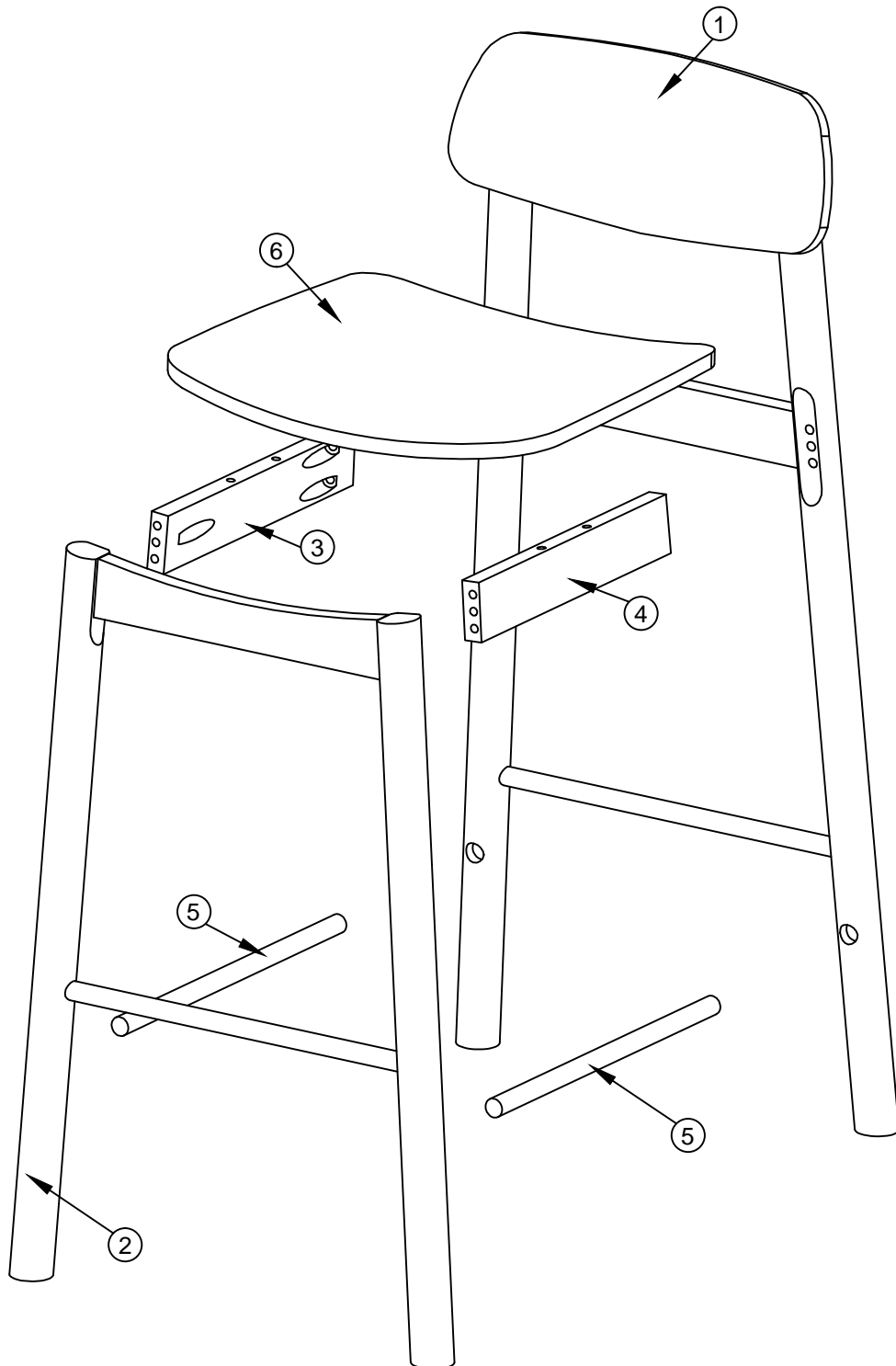
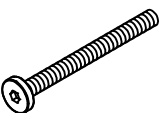

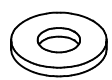
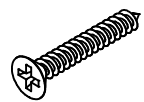
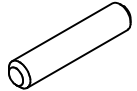
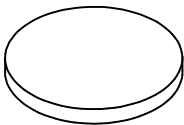
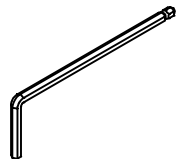
<p>A x 10</p>  <p>M6 x 50 mm</p>	<p>B x 10</p>  <p>Ø6/Ø13 mm</p>	<p>C x 10</p>  <p>Ø6/Ø13 mm</p>	<p>D x 4</p>  <p>Ø4 x 32 mm</p>	<p>E x 6</p>  <p>Ø8x30 mm</p>
<p>F x 4</p>  <p>Ø30x3 mm</p>	<p>G x 1</p>  <p>4 mm</p>			

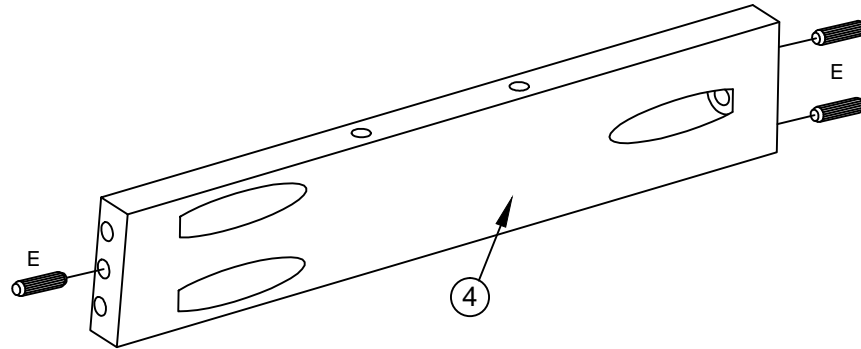
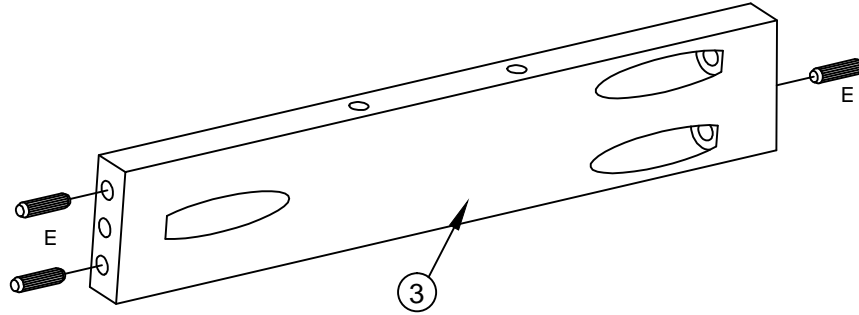
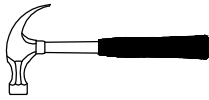
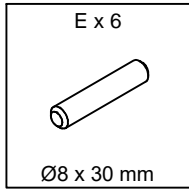

1

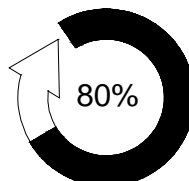
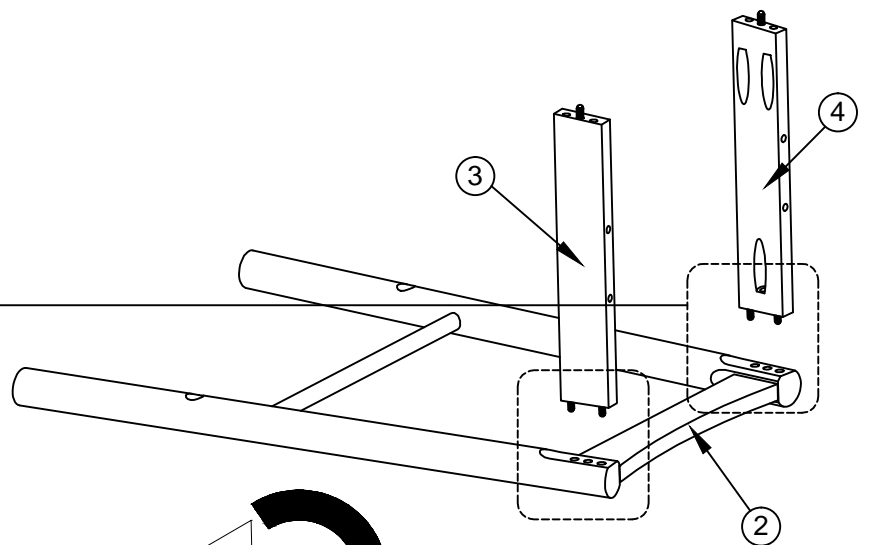
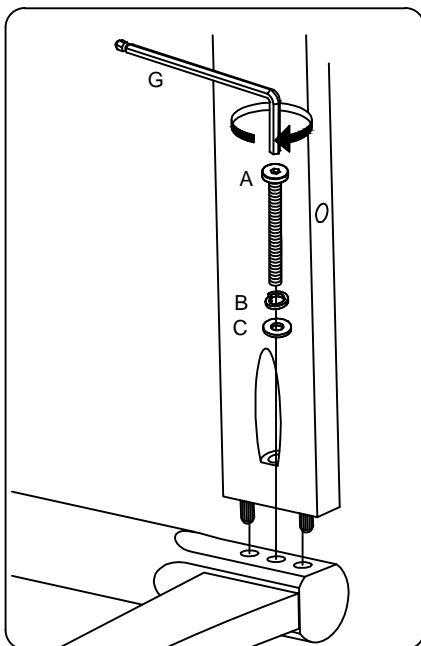
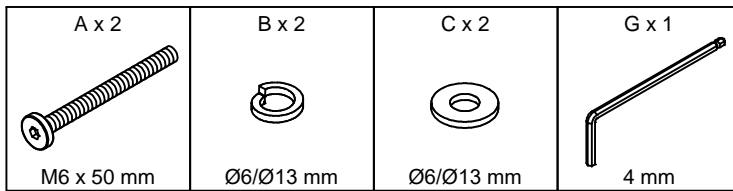

2



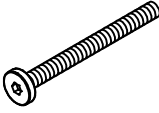

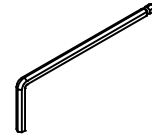
3

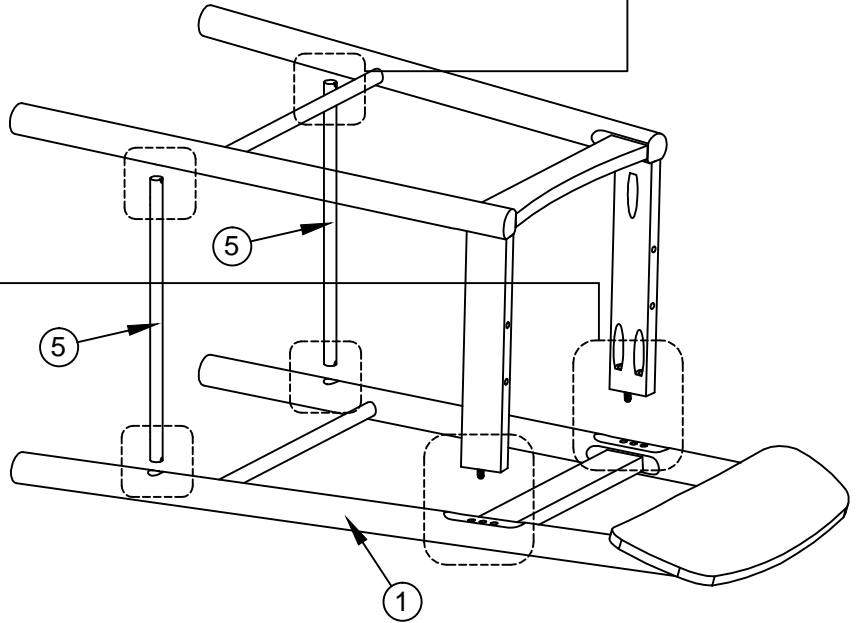
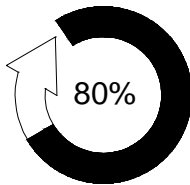
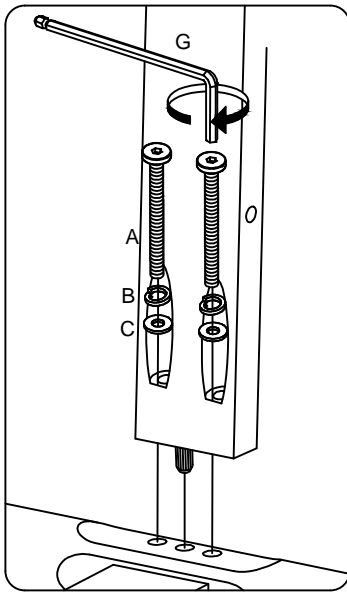
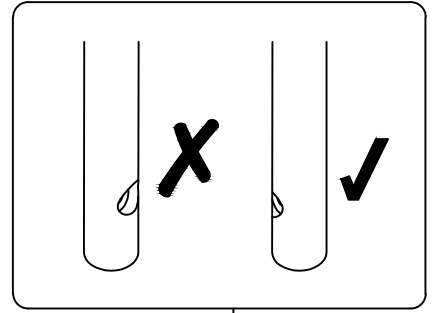
A x 4  M6 x 50 mm	B x 4  Ø6/Ø13 mm	C x 4  Ø6/Ø13 mm	G x 1  4 mm
--	---	---	--

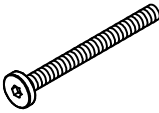

4

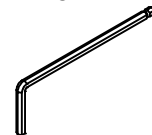
A x 4  M6 x 50 mm	B x 4  Ø6/Ø13 mm	C x 4  Ø6/Ø13 mm	G x 1  4 mm
--	---	---	--

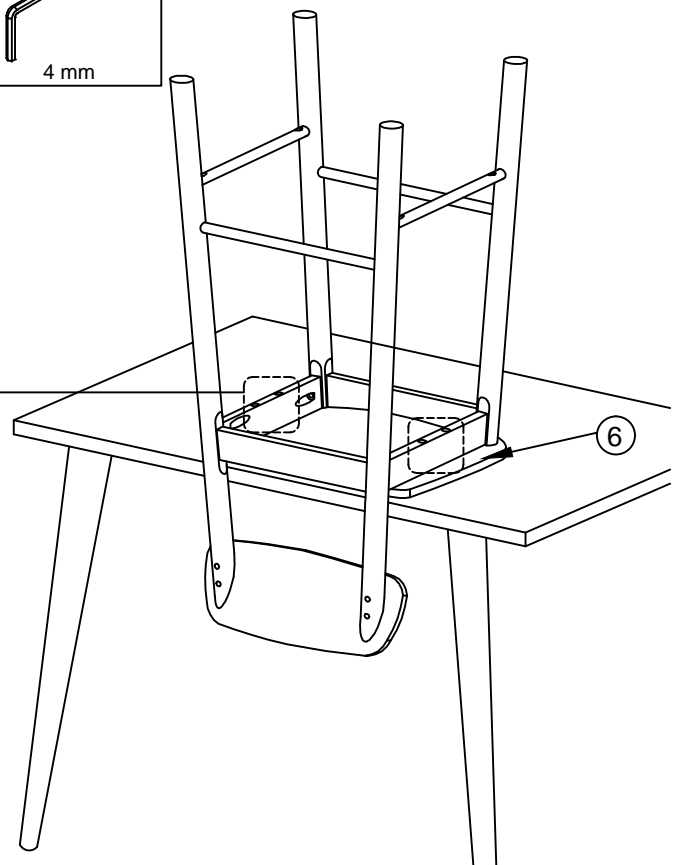
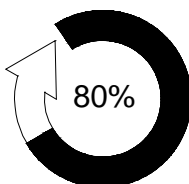
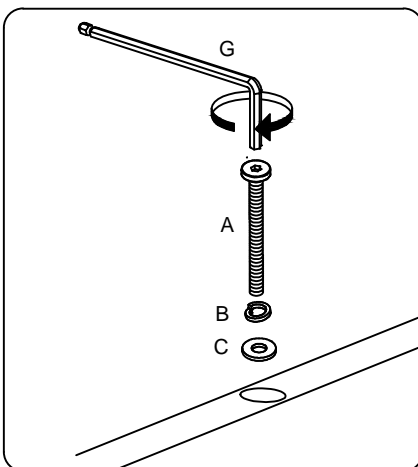

5

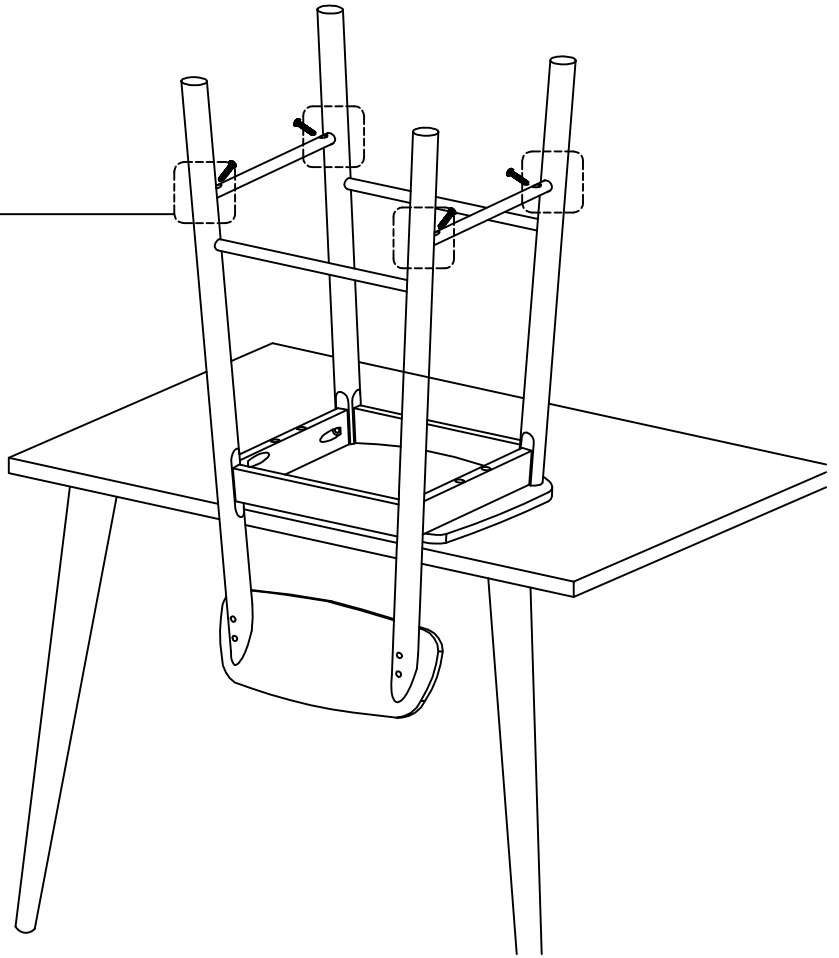
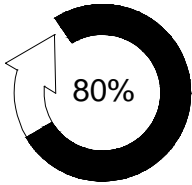
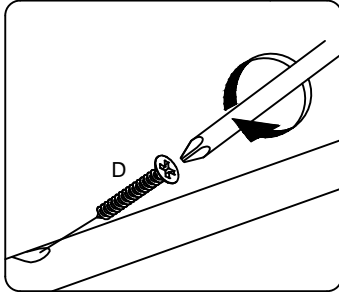
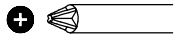
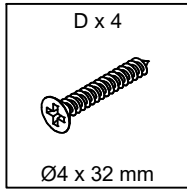

6

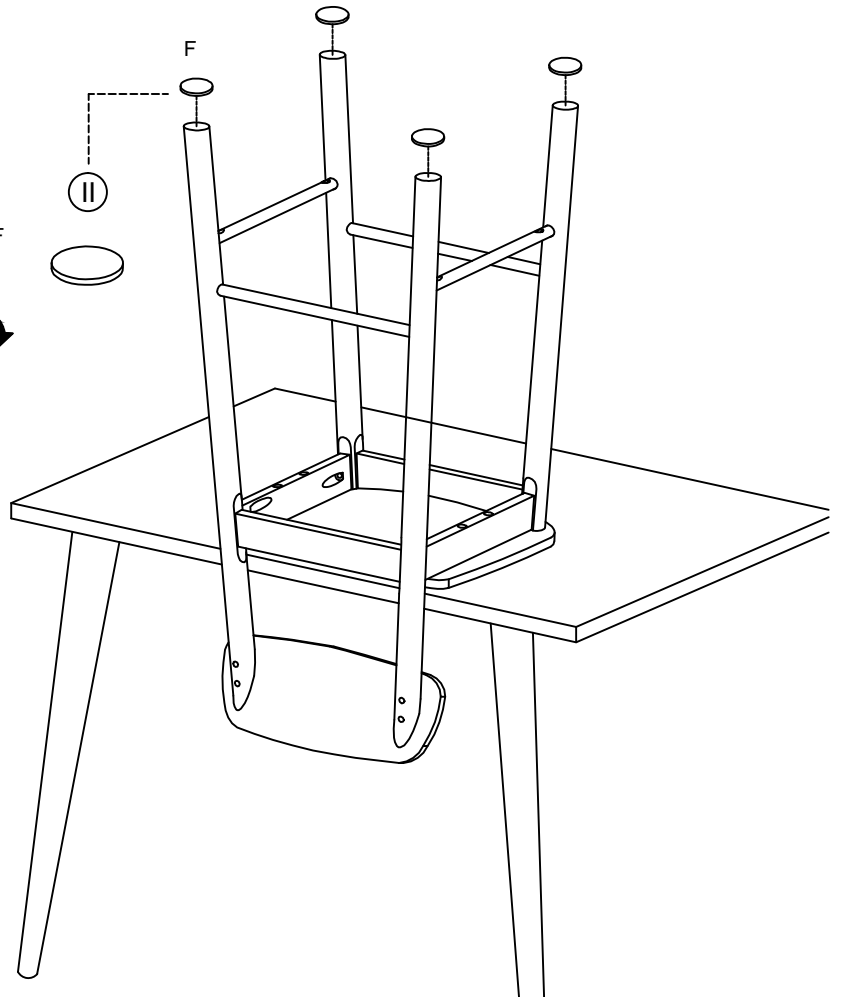
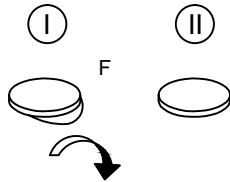
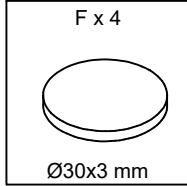

7

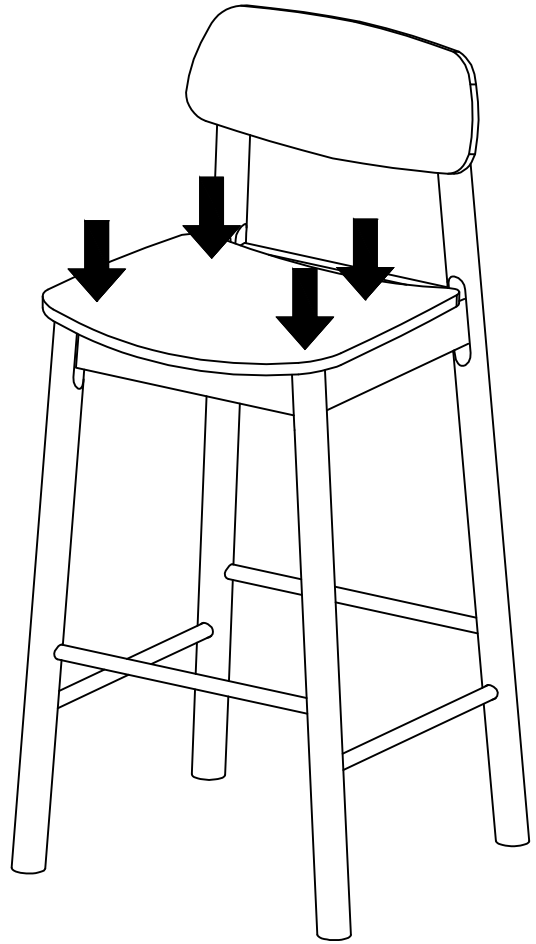
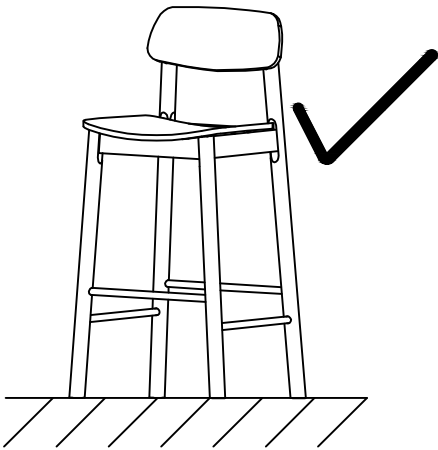
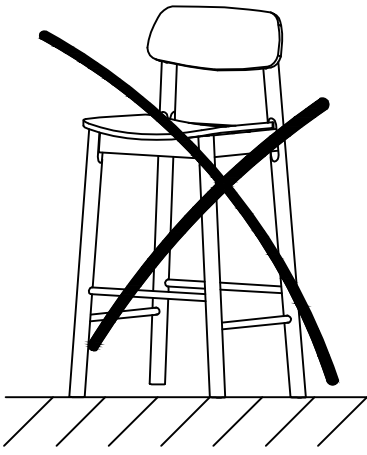

8

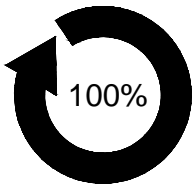
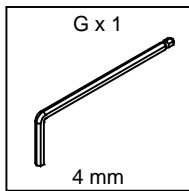

A x 10

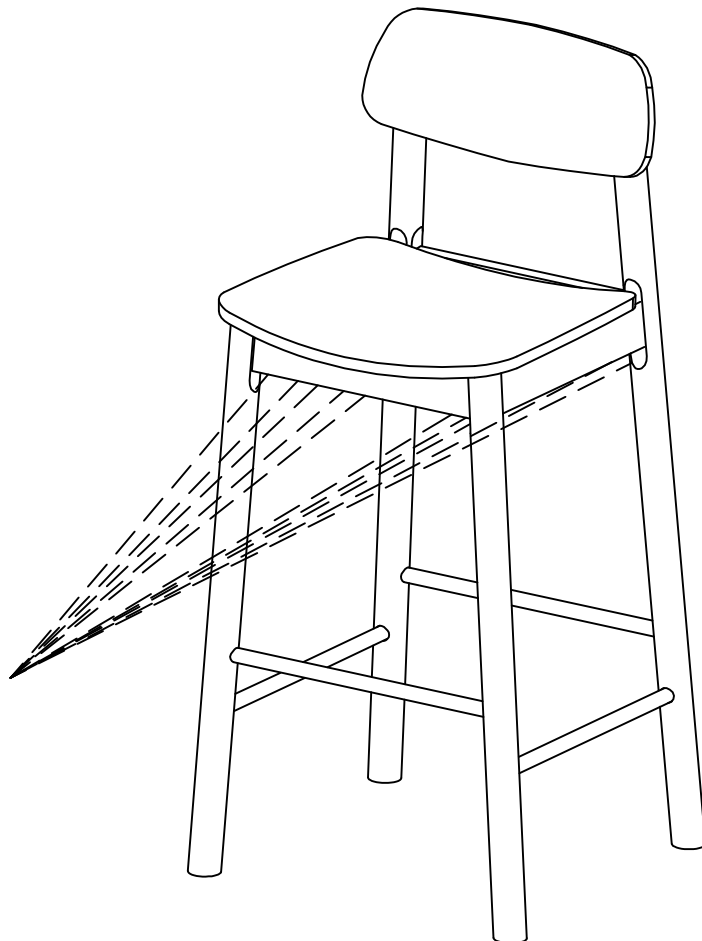
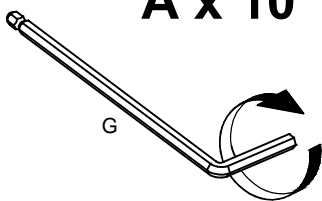

9

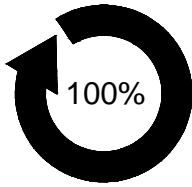
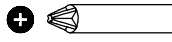
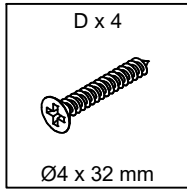

D x 4

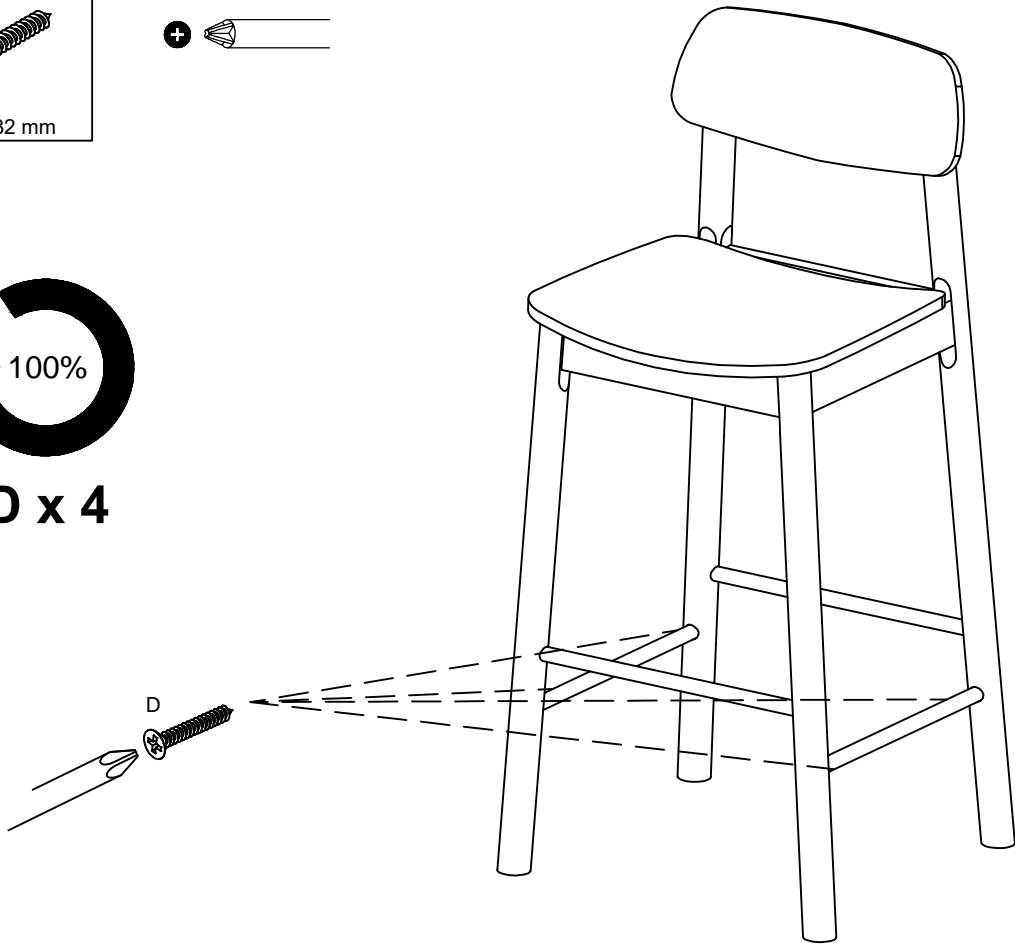

10

