

**NOTICE DE MONTAGE  
ASSEMBLY INSTRUCTIONS  
MONTAGEANLEITUNG  
ISTRUZIONI DI MONTAGGIO  
INSTRUÇÕES DE MONTAGEM  
INSTRUCCIONES DE MONTAJE  
UPUTE ZA MONTAZU  
MONTAJ TALIMATI**

16324  
16328  
16385  
**COMODA 4+3C  
CHEST 4+3DR  
COMMUNE 4+3T**

**ME**  
marckeric

MARCKERIC S.L.  
C/ ENLACE VEROLA S/N,  
PC. 46430/SOLLANA / VALÈNCIA / SPAIN

**EAN CODE: 8435178399373  
8435178399335  
8435178399878**

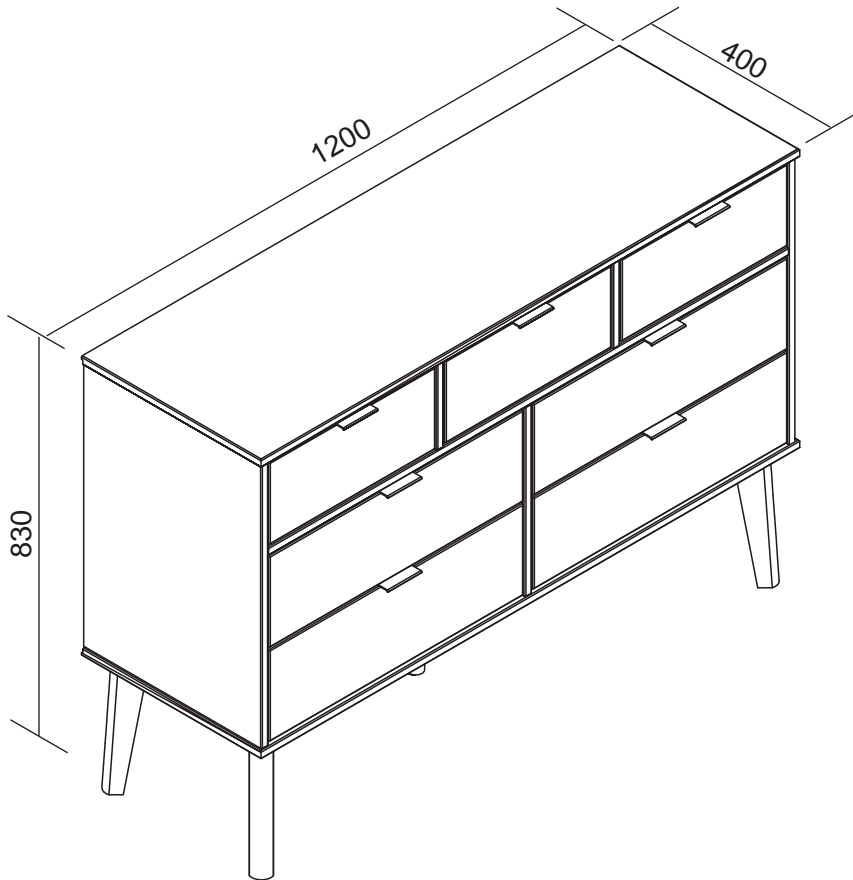

**\*À MONTER SOI-MÊME\***

*AVANT DE COMMENCER, SE  
REPORTER AUX CONSEILS  
DE MONTAGE EN ANNEXE*

**BEFORE STARTING, REFER  
TO THE ASSEMBLING ADVICE  
IN ANNEX**

*VOR DER MONTAGE,  
BEILIEGENDE ANWEISUNGEN  
BEFOLGEN.*

*PRIMA DI COMINCIARE  
LEGGETE LE ISTRUZIONI DI  
MONTAGGIO*

*ANTES DE COMENÇAR, ADIAR  
SE AOS CONSELHOS DE  
MONTAGEM EM ANEXO*

**ANTES DE EMPEZAR  
CONSULTE LOS CONSEJOS  
PARA EL MONTAJE**

*PRIFE POČETKA MONTAŽE  
MOLIMO PAŽLJIVO  
PROČITAJTE UPUTE ZA  
MONTAŽU*

**BASLAMADAN ÖNCE,  
EKTEKI MONTAJ TALIMATLARINI  
İNCELEYİNİZ**

**\*IMPORTANT: À CONSERVER POUR RÉFÉRENCE ULTÉRIEURE - LIRE ATTENTIVEMENT\*  
NE PAS UTILISER SI UNE PARTIE EST CASSÉE, ENDOMMAGÉE OU MANQUANTE**

| Tamaño de la caja<br>Dimensions colis | Peso bruto<br>Poids brut | Peso neto<br>Poids net |
|---------------------------------------|--------------------------|------------------------|
| 1345 x 425 x 155 mm                   | 32,8 Kg                  | 31,4 Kg                |

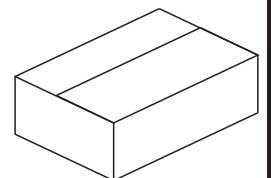

1PC / 1CTN

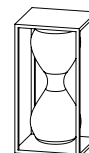
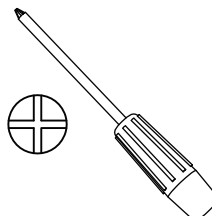
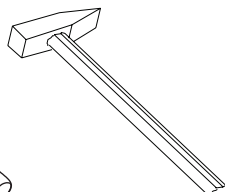
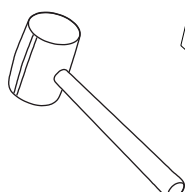
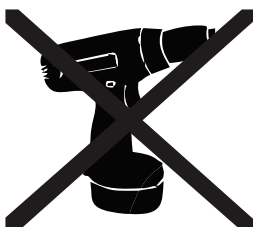

**100min.**

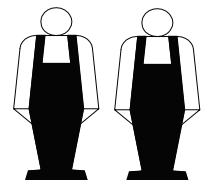

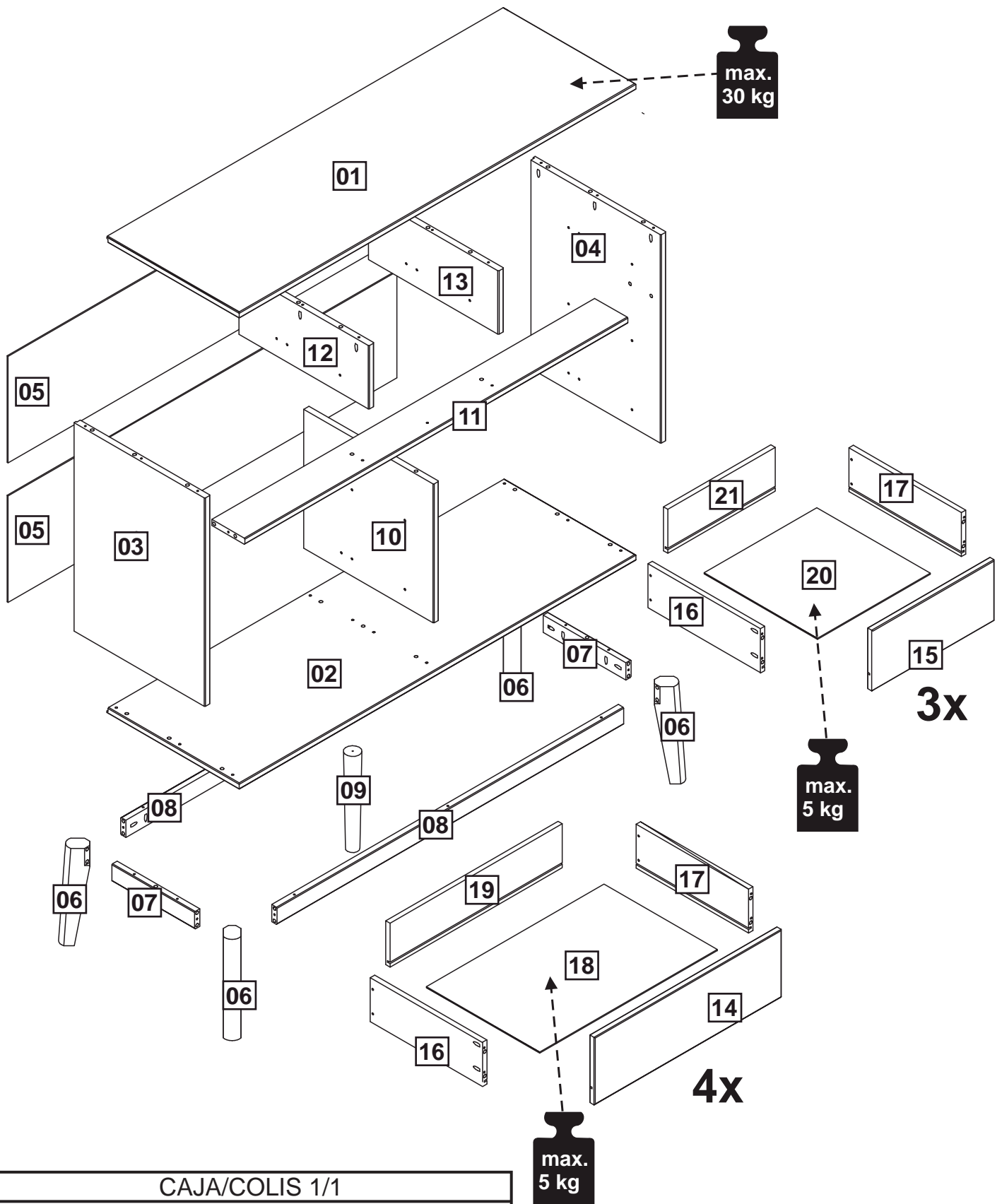

CAJA/COLIS 1/1

|             |              |              |
|-------------|--------------|--------------|
| 1x PIECES 1 | 2x PIECES 8  | 3x PIECES 15 |
| 1x PIECES 2 | 1x PIECES 9  | 7x PIECES 16 |
| 1x PIECES 3 | 1x PIECES 10 | 7x PIECES 17 |
| 1x PIECES 4 | 1x PIECES 11 | 4x PIECES 18 |
| 2x PIECES 5 | 1x PIECES 12 | 4x PIECES 19 |
| 4x PIECES 6 | 1x PIECES 13 | 3x PIECES 20 |
| 2x PIECES 7 | 4x PIECES 14 | 3x PIECES 21 |

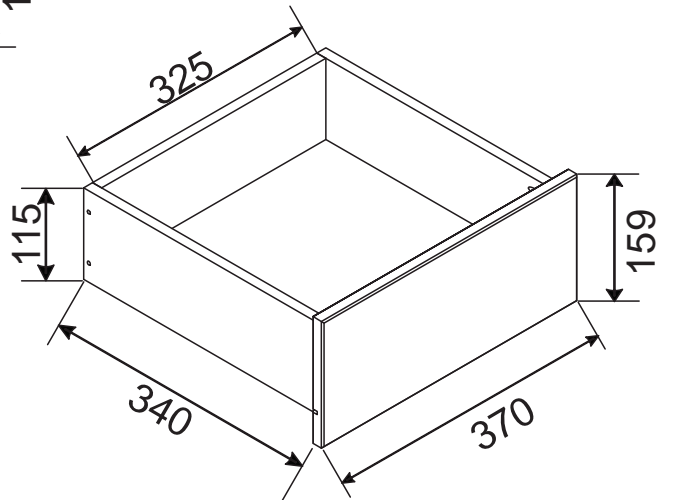
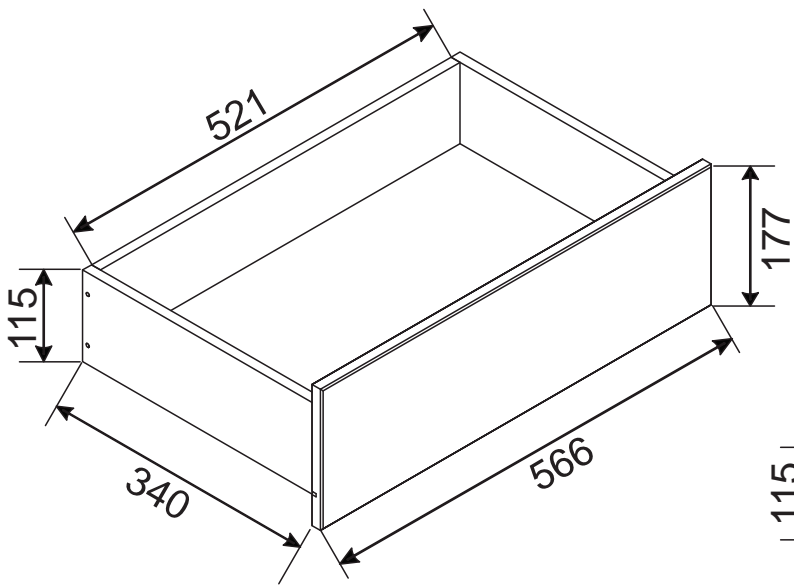
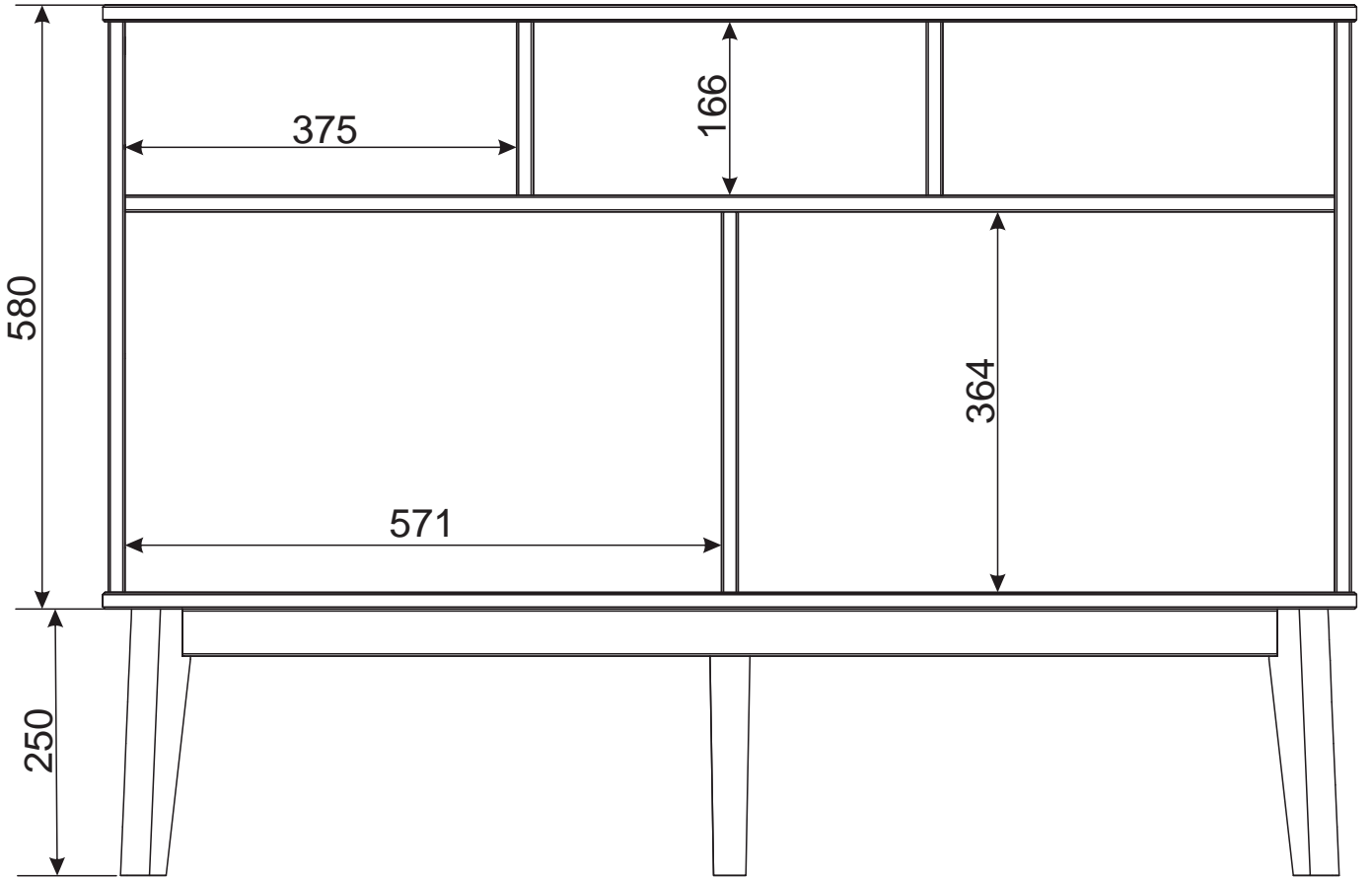

QUINCALLERIE  
NOTICE DE  
MONTAGE



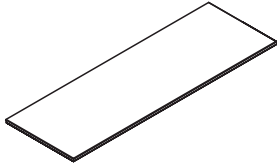
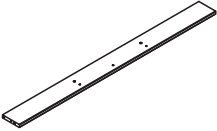
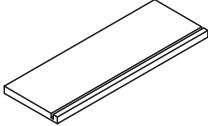
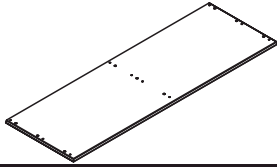
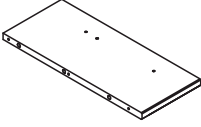
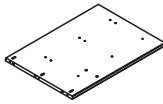
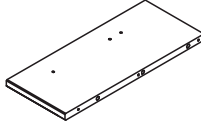
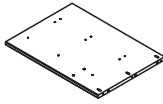
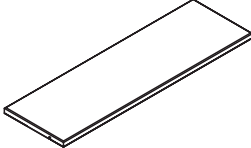
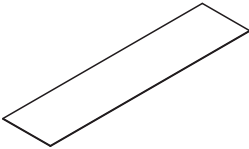
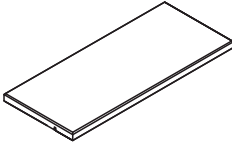
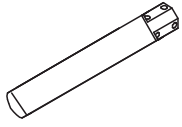
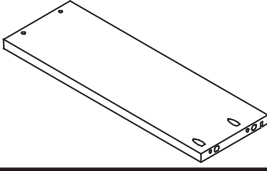
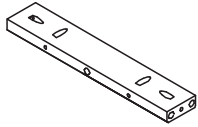
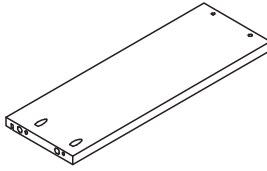
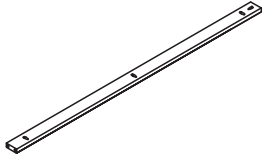
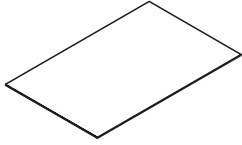
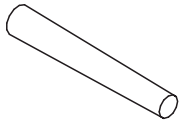
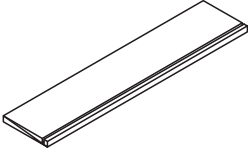
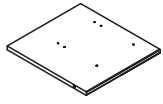
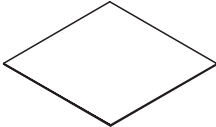



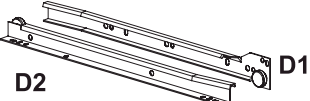

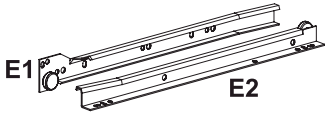
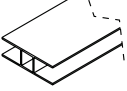
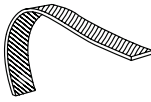
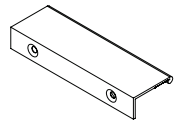
# LISTADO DE PIEZAS - COMPOSANTS - PARTS LIST

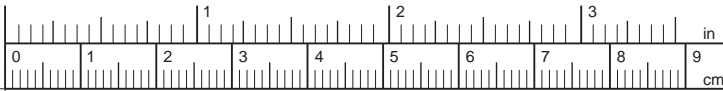
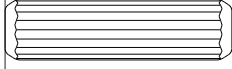
|    |   |      |    |   |      |    |   |      |
|----|---|------|----|---|------|----|---|------|
| 01 |    | 01pc | 11 |    | 01pc | 21 |  | 03pc |
| 02 |    | 01pc | 12 |    | 01pc |    |   |      |
| 03 |    | 01pc | 13 |    | 01pc |    |   |      |
| 04 |    | 01pc | 14 |    | 04c  |    |   |      |
| 05 |   | 02pc | 15 |   | 03pc |    |   |      |
| 06 |  | 04pc | 16 |  | 07pc |    |   |      |
| 07 |  | 02pc | 17 |  | 07pc |    |   |      |
| 08 |  | 02pc | 18 |  | 04pc |    |   |      |
| 09 |  | 01pc | 19 |  | 04pc |    |   |      |
| 10 |  | 01pc | 20 |  | 03pc |    |   |      |

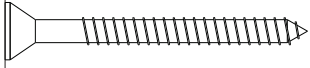
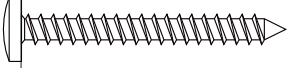
# HERRAJES - QUINCALLERIE - HARDWARE

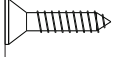
|          |   |           |          |   |           |
|----------|---|-----------|----------|---|-----------|
| <b>D</b> |  | <b>07</b> | <b>K</b> |  | <b>02</b> |
| <b>E</b> |  | <b>07</b> | <b>L</b> |  | <b>01</b> |
| <b>J</b> |  | <b>01</b> | <b>P</b> |  | <b>07</b> |

|              |   |  |               |
|--------------|---|--|---------------|
| <b>A</b> x74 |   |  | <b>8,0x30</b> |
| <b>B</b> x80 |  |  | <b>4,0x30</b> |
| <b>C</b> x13 |  |  | <b>4,0x40</b> |
| <b>F</b> x08 |  |  | <b>4,5x35</b> |
| <b>G</b> x28 |  |  | <b>6,0x10</b> |
| <b>H</b> x71 |  |  | <b>3,0x12</b> |
| <b>N</b> x38 |  |  | <b>1,8x20</b> |

01

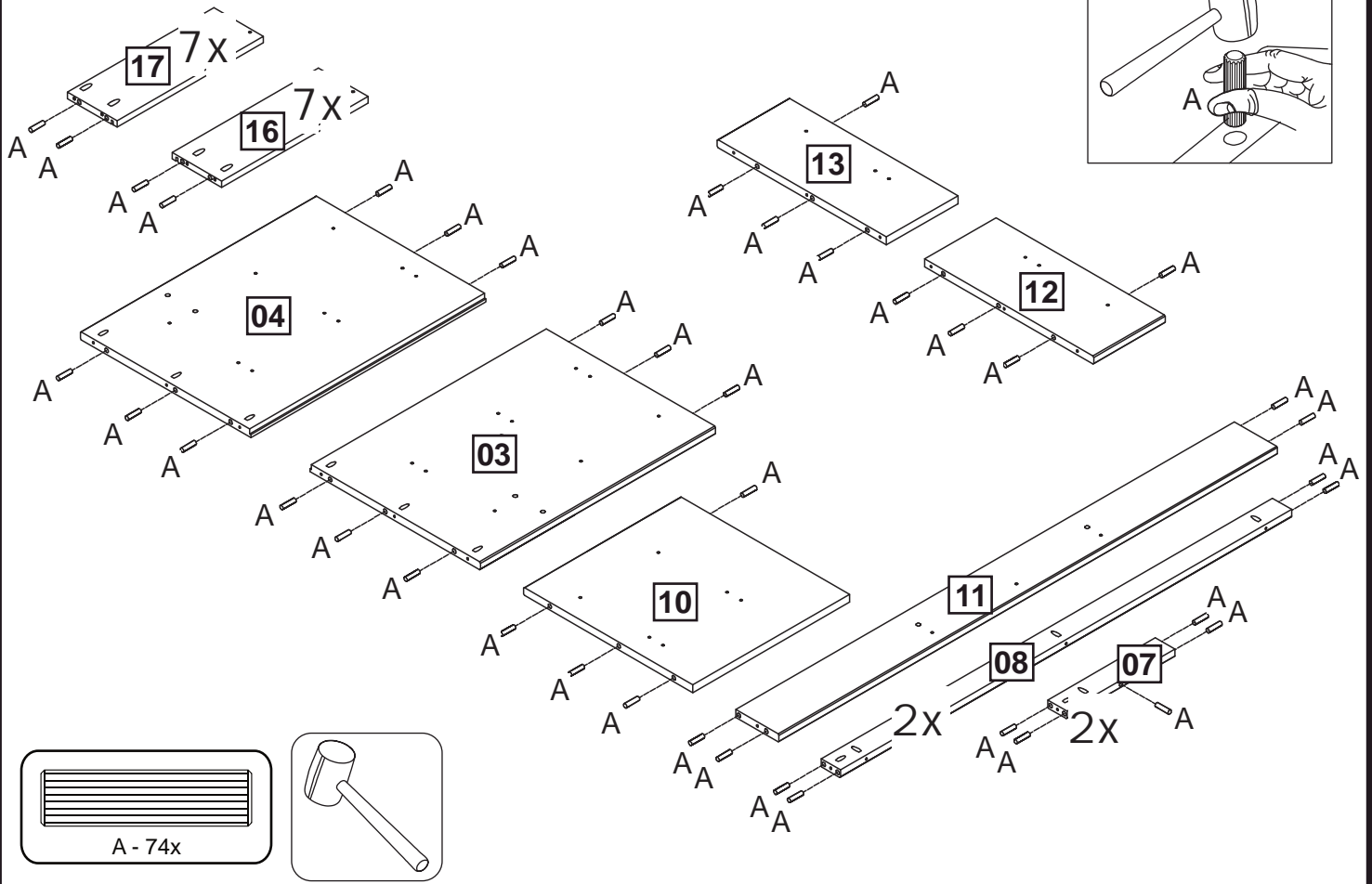

02

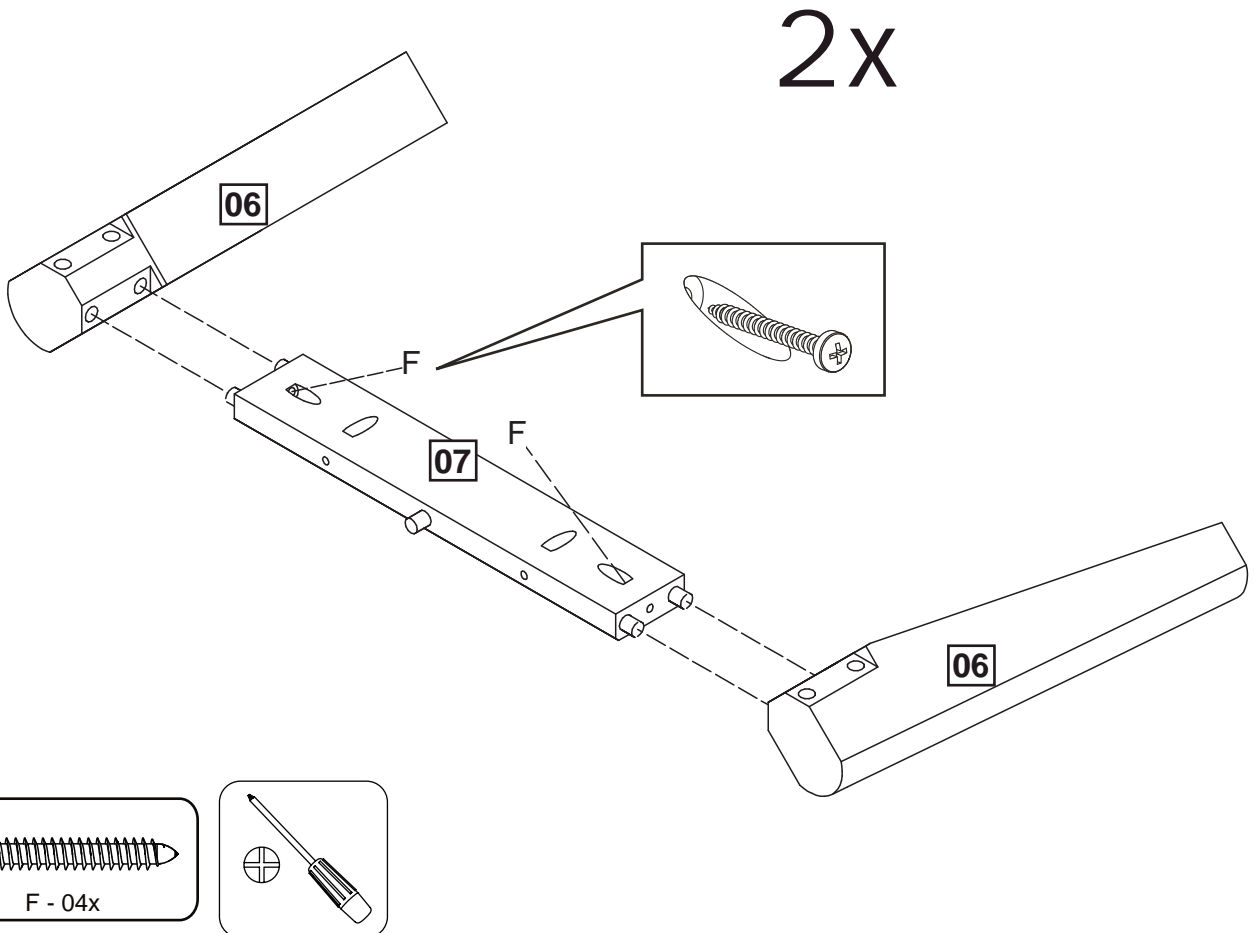

03

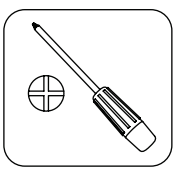
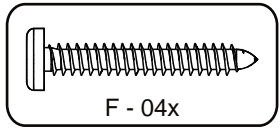
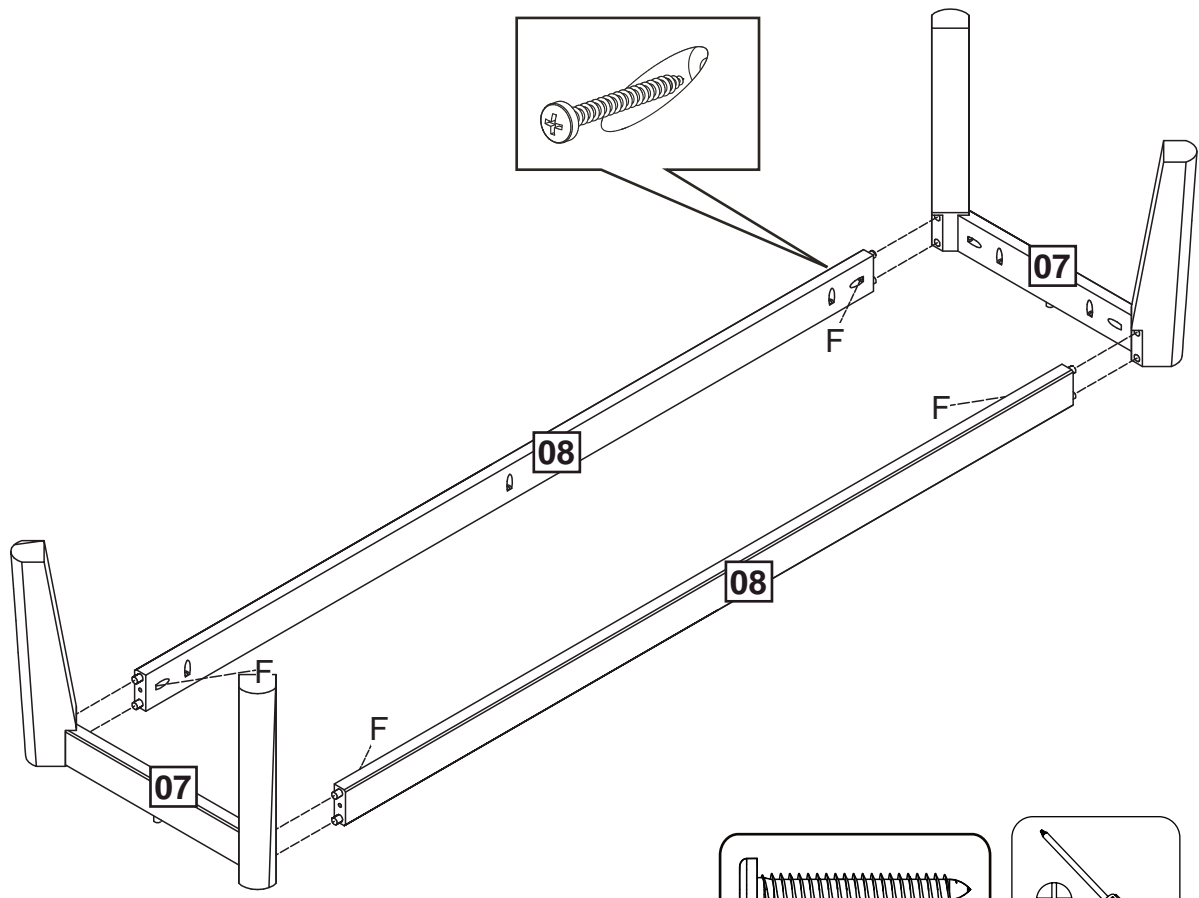

04

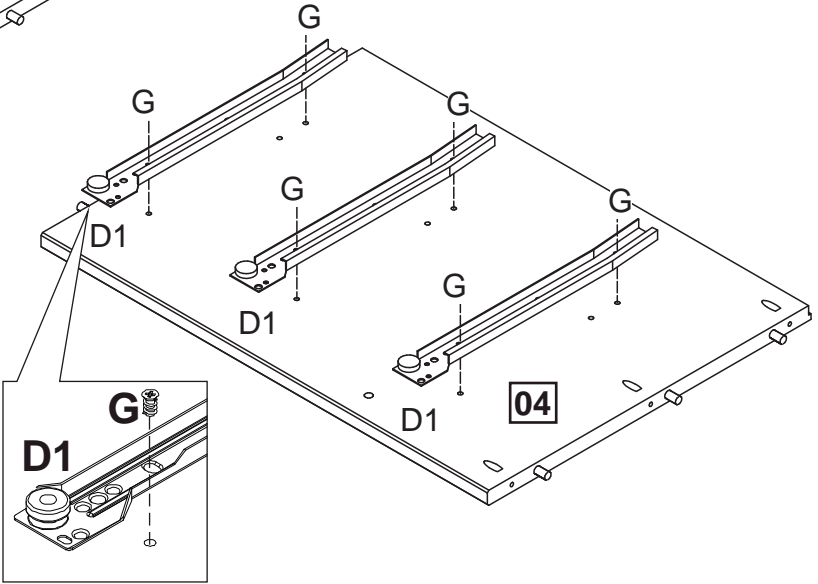
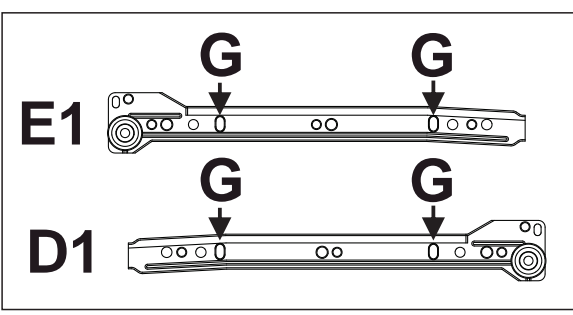
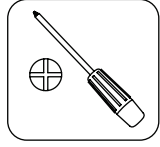
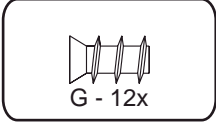
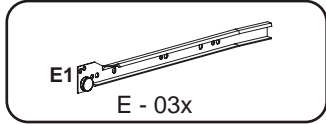
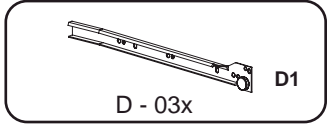
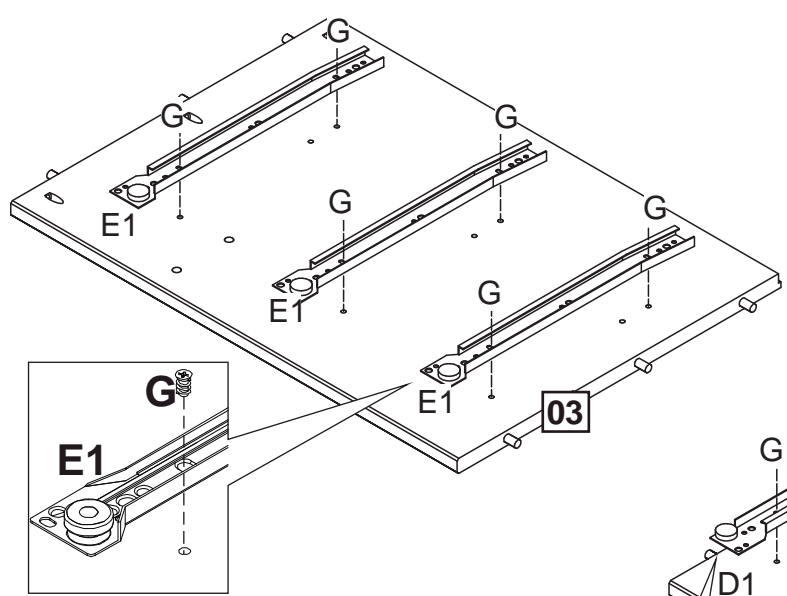

05

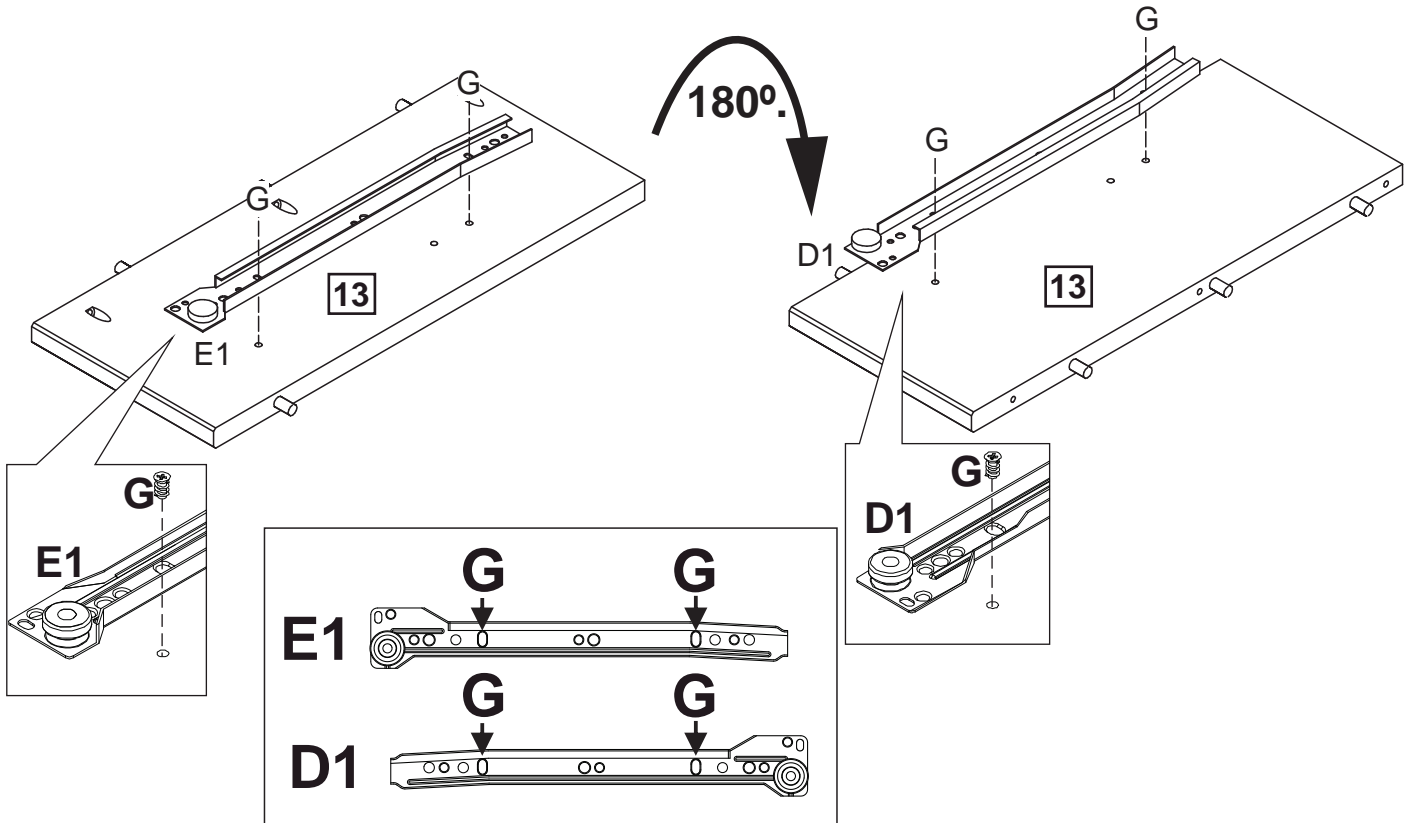
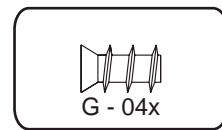
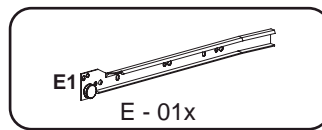
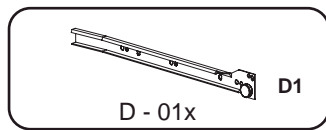

06

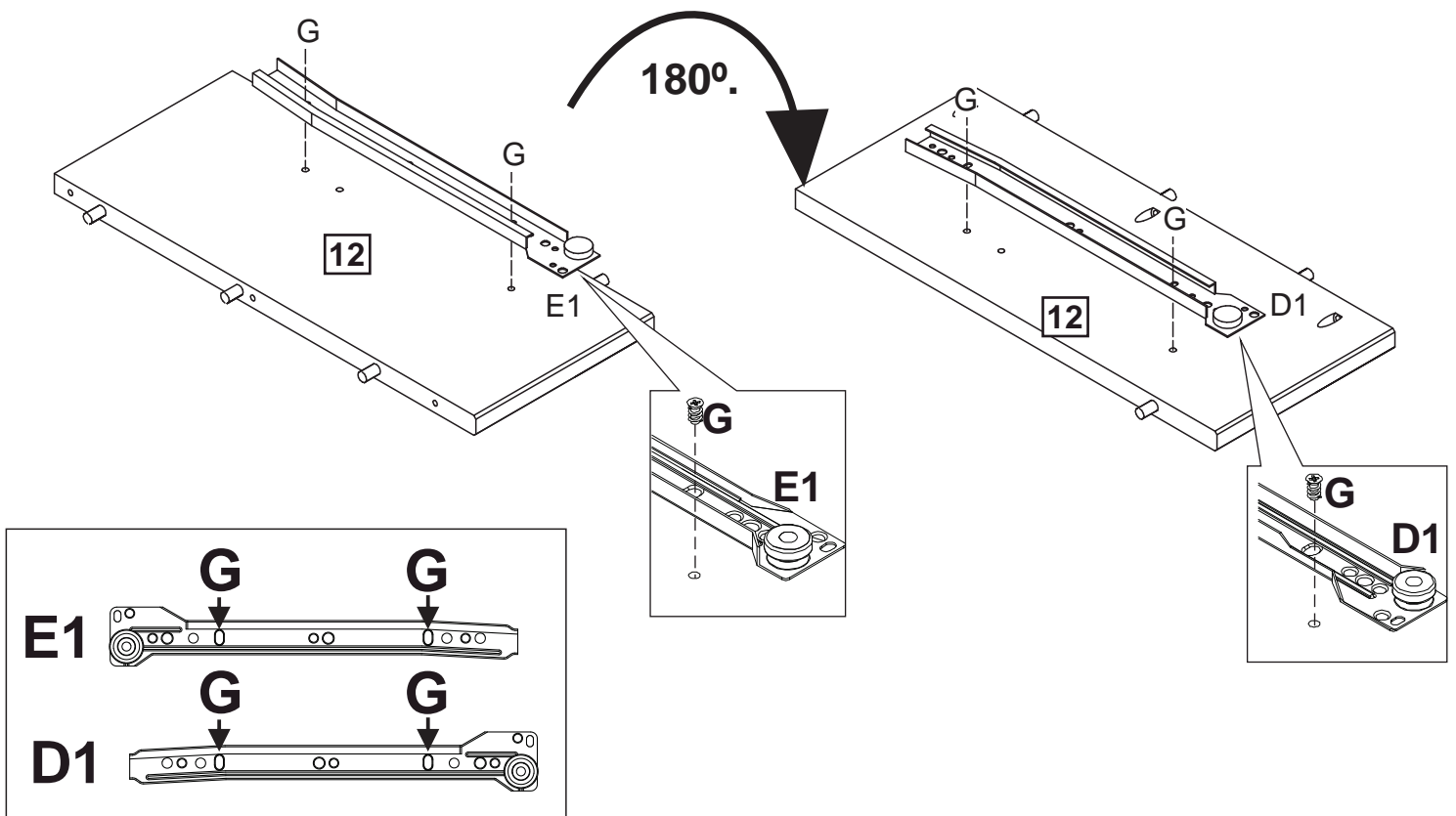
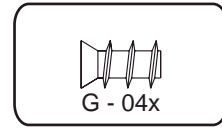
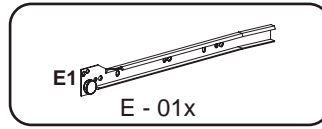
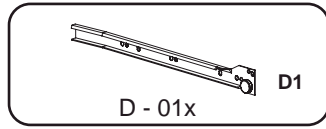



07

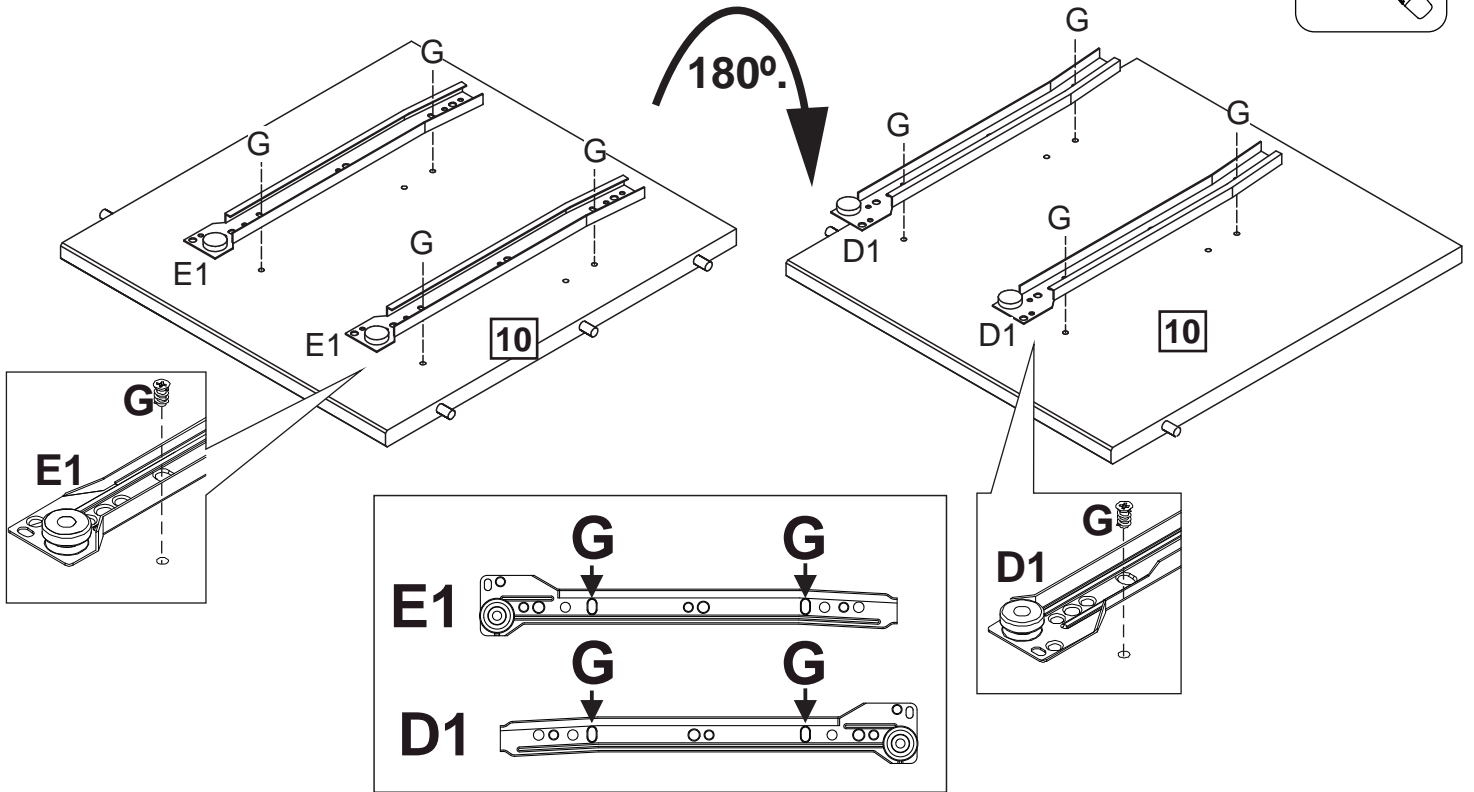
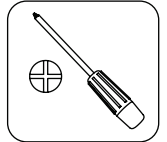
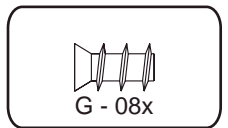
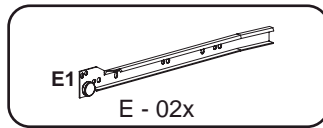
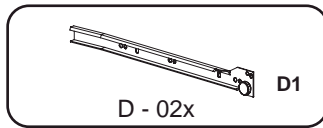

08

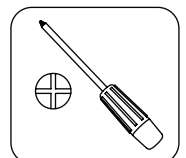
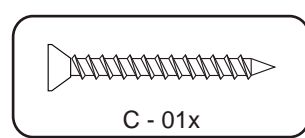
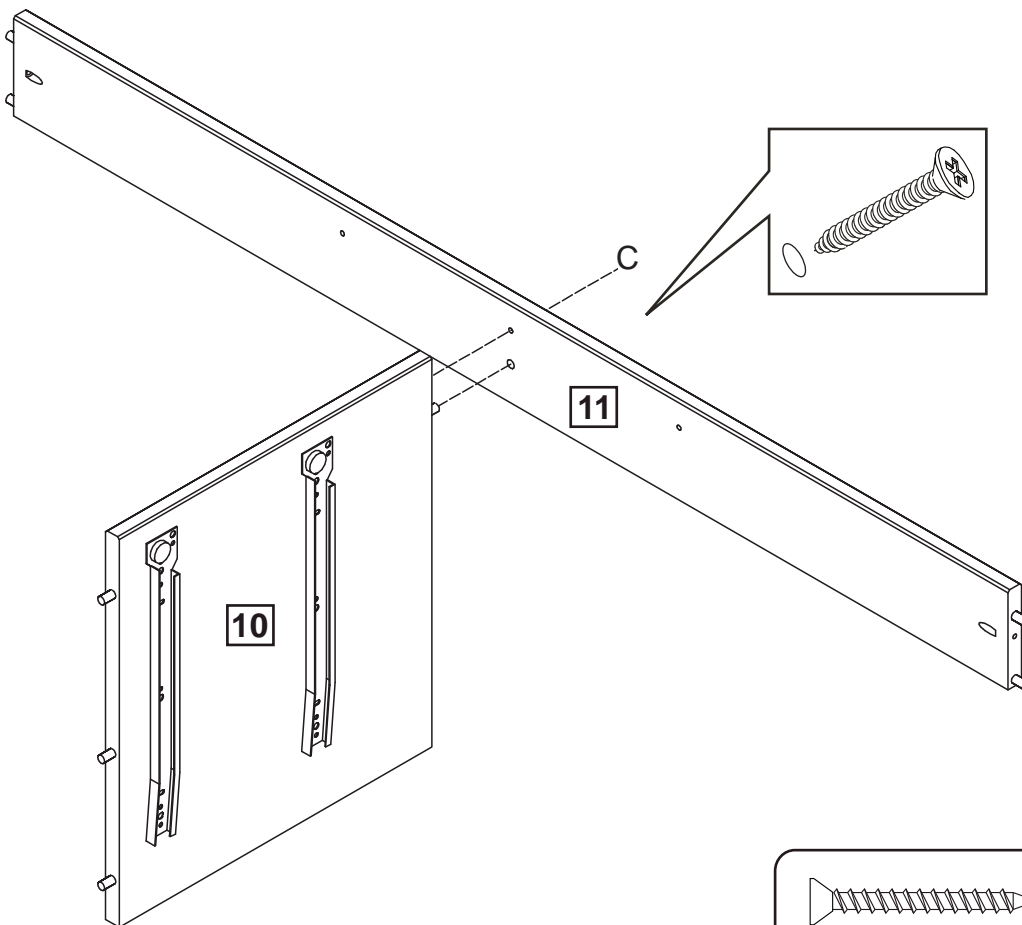

09

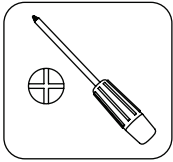
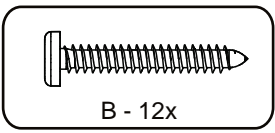
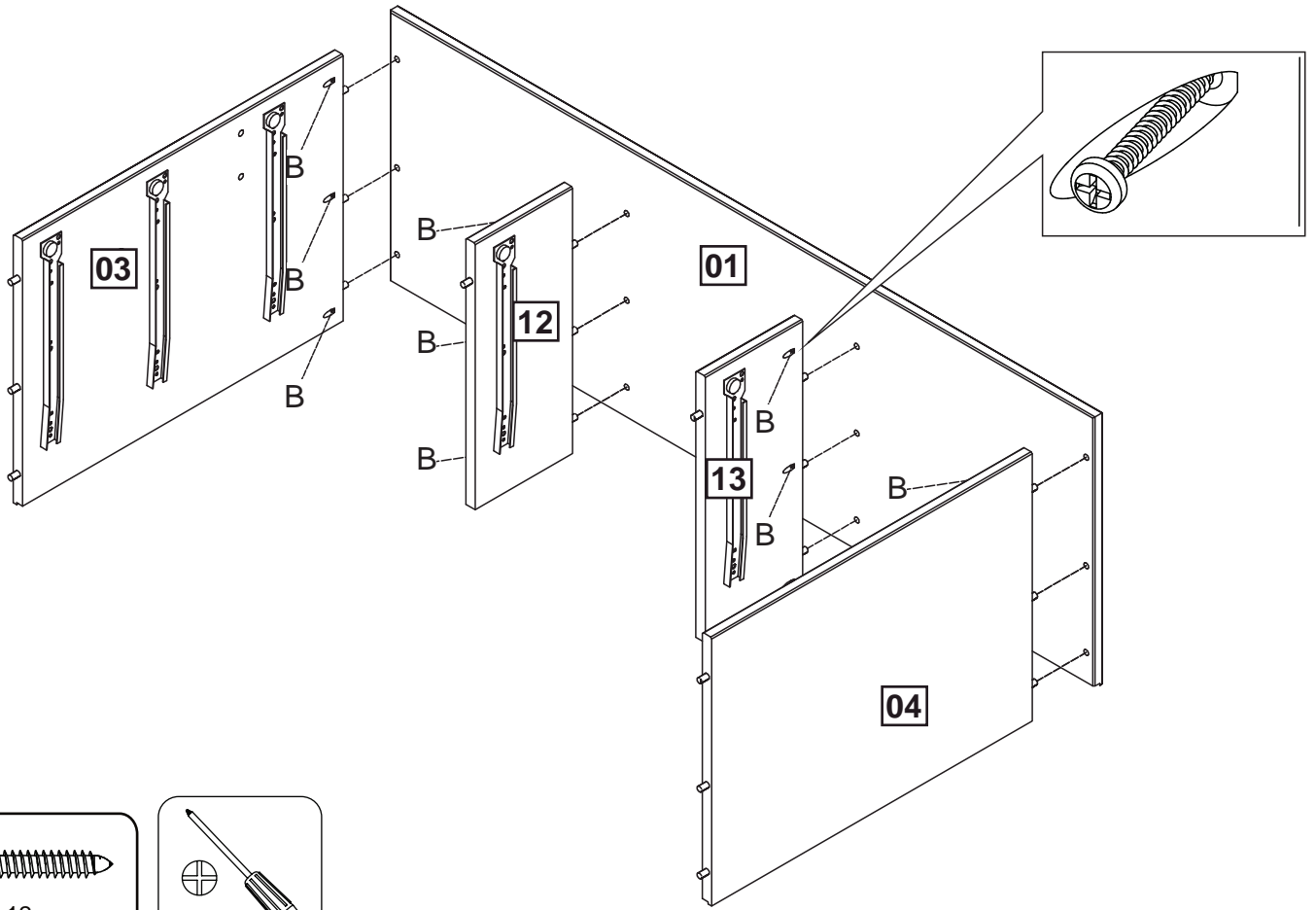

10

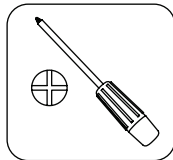
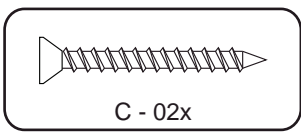
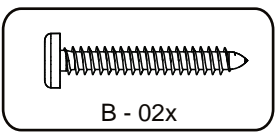
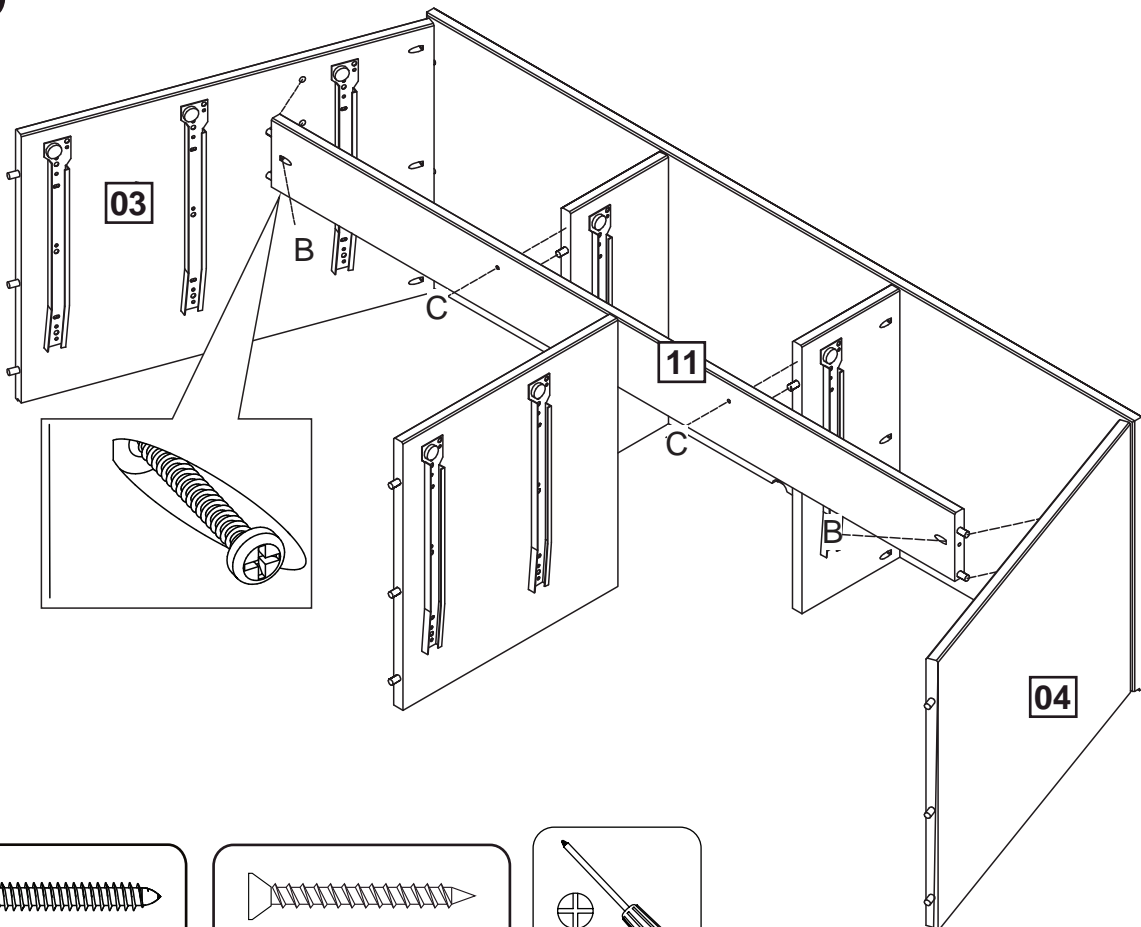

11

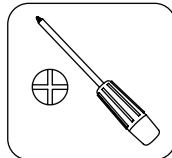
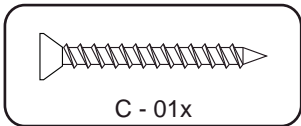
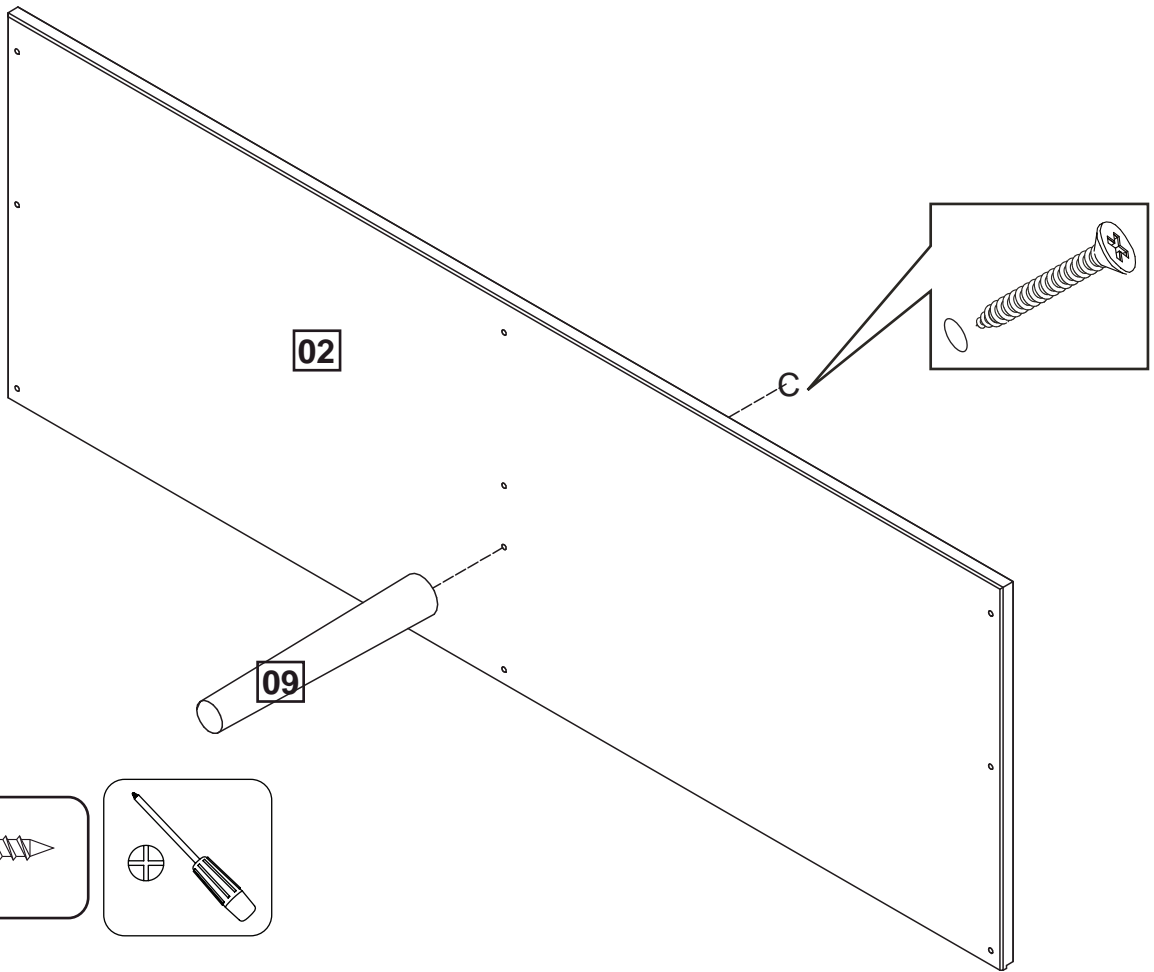

12

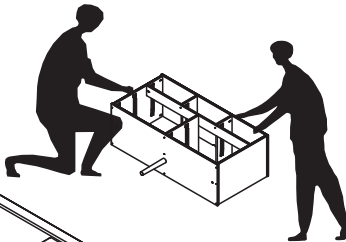

**FRENCH:** Basculer le meuble avec précaution. Utilisez une couverture recommandée pour ne pas abîmer le meuble.

**SPANISH:** Girar el mueble con cuidado. Utilice un cobertor para evitar daños en el mueble.

**ENGLISH:** Turn the furniture carefully. Use a cover to avoid damage the furniture.

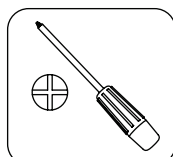
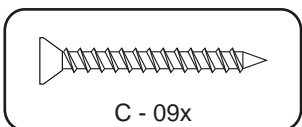
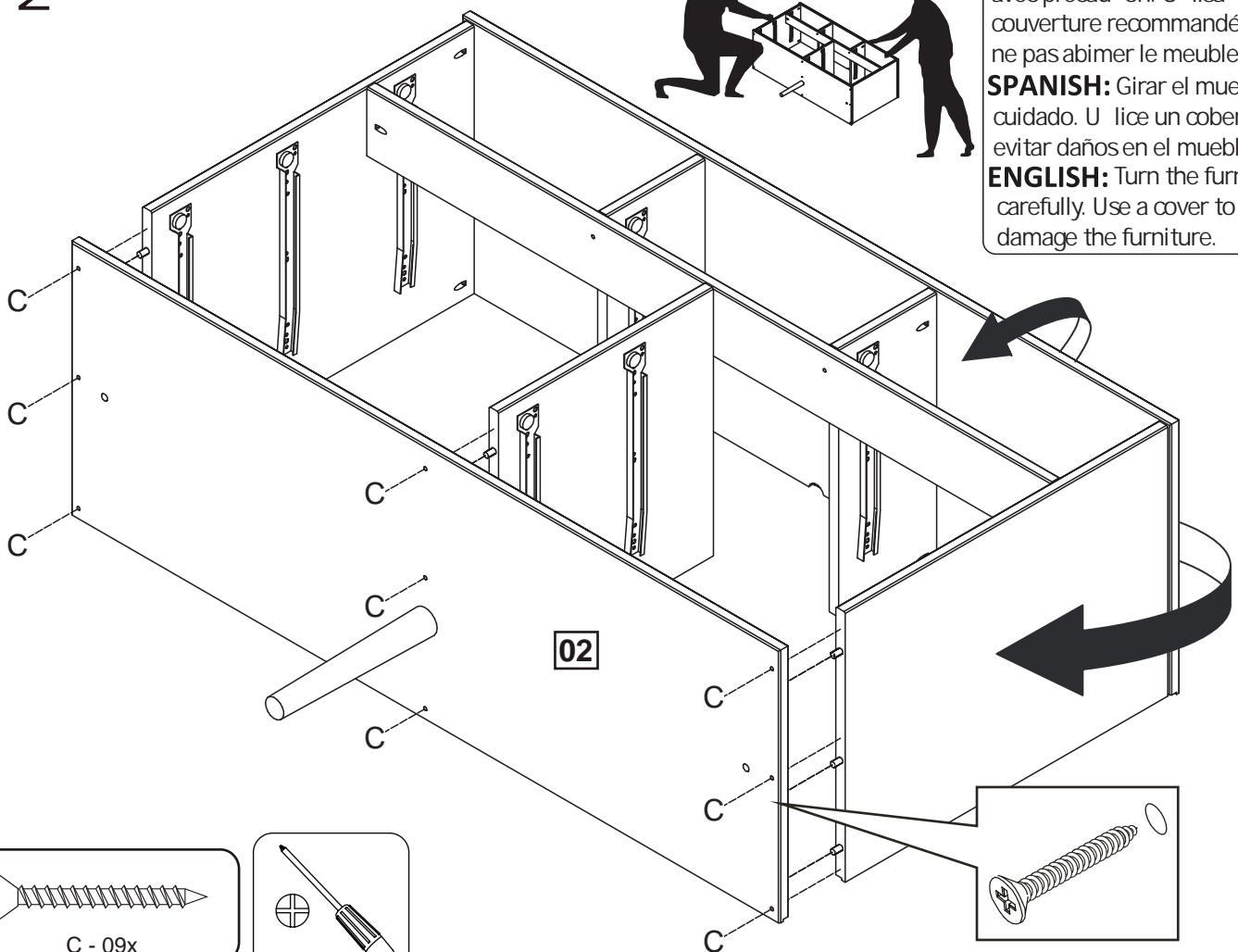

# 13

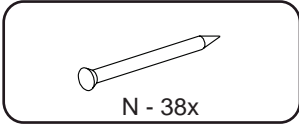
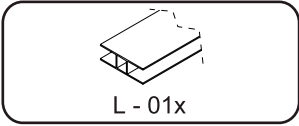

**SPANISH:**  
En caso de reclamación, por favor, facilitar la información escrita en la etiqueta.

**FRENCH:**  
En cas de réclamation, merci de transmettre les informations contenues sur l'étiquette fixée sur le produit.

**ENGLISH:**  
If you may have whatever complaint, please, let us know the information written on the label.

MAR-XXX-XX

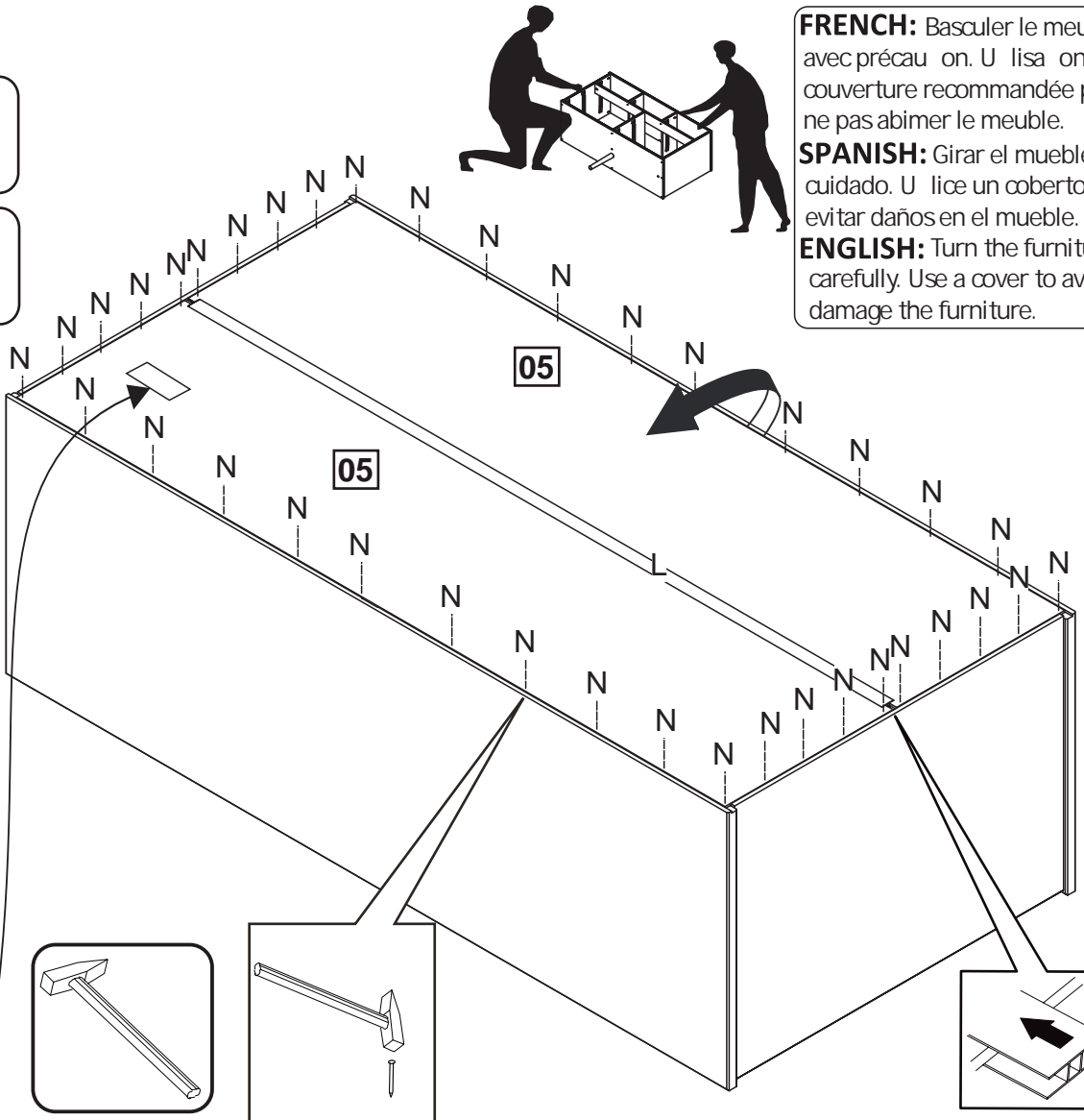

**FRENCH:** Basculer le meuble avec précaution. Utilisez une couverture recommandée pour ne pas abîmer le meuble.

**SPANISH:** Girar el mueble con cuidado. Utilice un cobertor para evitar daños en el mueble.

**ENGLISH:** Turn the furniture carefully. Use a cover to avoid damage the furniture.

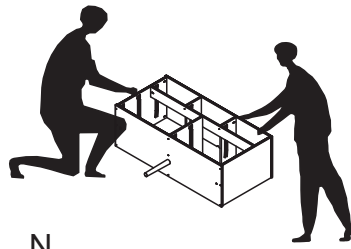

# 14

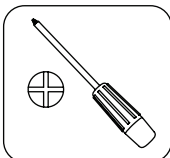
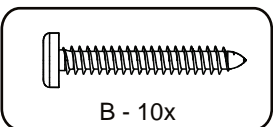
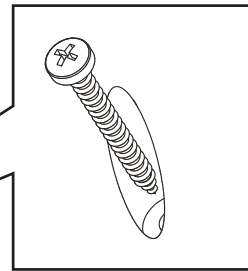
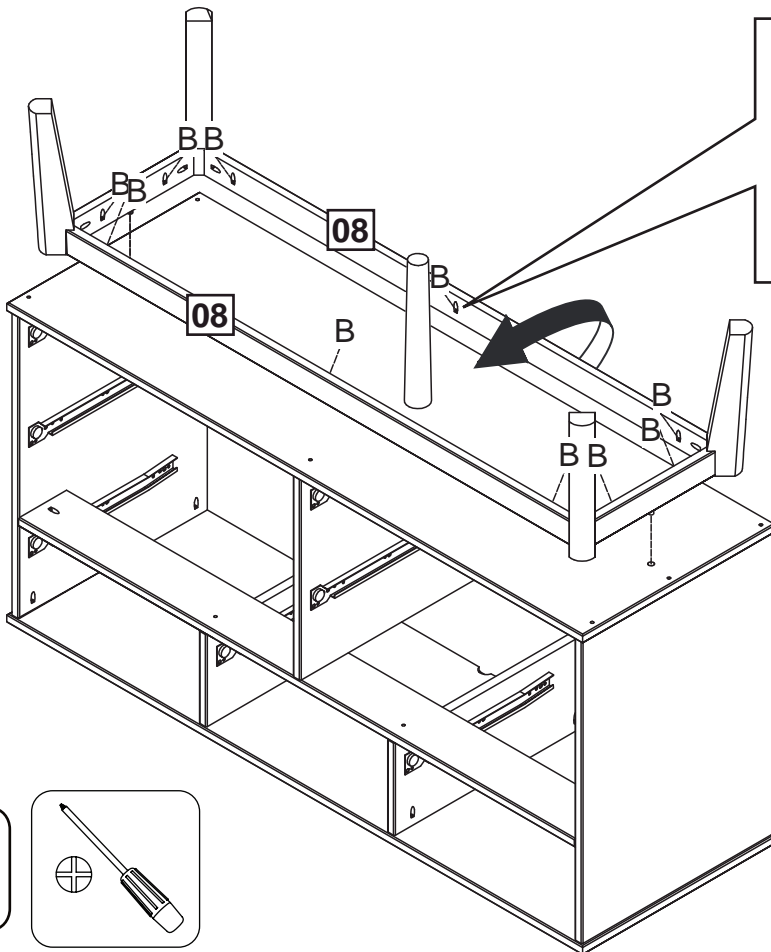

**FRENCH:** Basculer le meuble avec précaution. Utilisez une couverture recommandée pour ne pas abîmer le meuble.

**SPANISH:** Girar el mueble con cuidado. Utilice un cobertor para evitar daños en el mueble.

**ENGLISH:** Turn the furniture carefully. Use a cover to avoid damage the furniture.

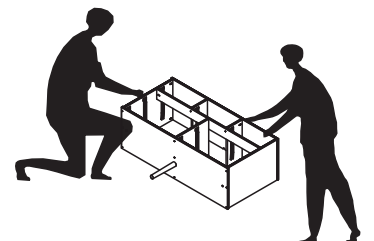



## FIXATION MURALE OBLIGATORIE

UTILISEZ DES VIS ET DES CHEVILLES ADAPTÉES A VOS MURS



Il existe une grande diversité de types de murs ou cloisons, c'est la raison pour laquelle nous ne pouvons vous fournir une quincaillerie adaptée à votre mur. Il est nécessaire d'identifier le type de paroi à laquelle vous allez fixer ce produit afin de vous procurer les fixations appropriées. En cas de besoin, adressez vous à un magasin spécialisé pour conseil



## OBLIGATORIO FIJAR A LA PARED

UTILICE LOS TORNILLOS Y TACOS ADECUADOS PARA SU MURO



Existe una gran diversidad de muros y paredes, por esta razón no podemos proporcionarle el herraje adecuado para su pared. Primero, es necesario identificar el tipo de pared para luego utilizar el herraje adecuado. En caso de duda, dirijase a una tienda especializada para más información.



## OBLIGATORY FIX ON THE WALL

USE SCREWS AND PLUGS SUITABLES FOR YOUR WALL



Due to the wide diversity of wall or partition types, we cannot provide you with suitable attachment fixtures. To determine which attachment fixtures to use, you will need to identify the type of wall to which you will be fixing this product. If you have whatever doubt, please, go to one specialised shop for further information.

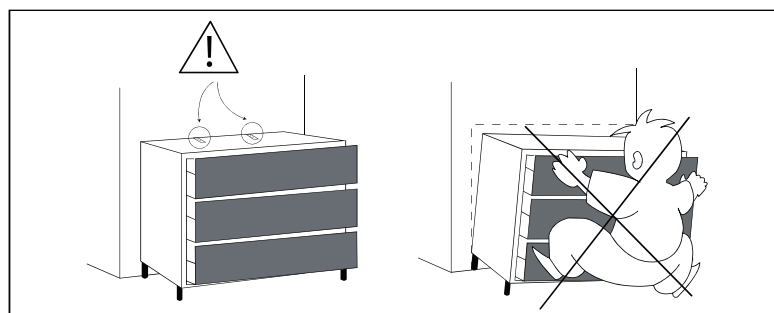

French

**IMPORTANT:** Pour éviter le basculement accidentel du meuble, la fixation du meuble au mur est obligatoire.

La visserie nécessaire pour la jonction mur/meuble, dépendante de la nature du mur, n'est pas fournie. En cas de doute, consulter un spécialiste

English

**IMPORTANT:** To avoid the accidental tip-over of the furniture, the fixing of the furniture on the wall is mandatory.

The needed hardware for the junction wall/furniture, depending of the nature of the wall, is not provided. If any doubt, consult a specialist.

Spanish

**IMPORTANTE:** Para evitar el vuelco accidental de los muebles, es obligatorio fijarlos en la pared.

El tipo de tornillos necesarios para fijar el mueble a la pared, dependen del material de la pared, no se suministran. En caso de duda, consulte a un especialista

Portuguese

**IMPORTANTE:** Para evitar a queda accidental de móveis, é obrigatorio fixá-los na parede. O tipo de parafusos para a fixação de mobiliário na parede, depende do material de parede e não são fornecidos. Em caso de dúvida, consulte um especialista.

Italian

**IMPORTANTE:** Per evitare il ribaltamento accidentale del mobile è obbligatorio il fissaggio a muro.

I tasselli necessari per il collegamento mobile\muro, dipendenti dal tipo di muro, non sono provvisti.

Consultare uno specialista in caso di dubbi

Croatian

**VAŽNO:** Kako bi se izbjeglo slučajno prevrtanje, namještaj je potrebno pričvrstiti na (uza) zid.

Različite vrste zidova zahtijevaju upotrebu različitih vrsta vijaka i tipli. Uvijek koristiti one koji su prikladni za vrstu zidova u domu. Vijci i tiplje prodaju se zasebno.

U slučaju bilo kakvih sumnji, obratite se stručnjaku.



German

**WICHTIG :** Um ein versehentliches Kippen des Möbels zu vermeiden, ist die Befestigung an der Wand zwingend vorgeschrieben.

Die benötigten Schrauben zur Wandbefestigung, welche von der Beschaffenheit der Mauer abhängen, sind nicht in der Lieferung enthalten. Wenden Sie sich bitte bei Zweifel an einen Spezialisten.

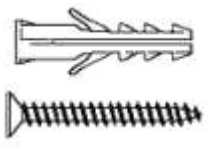
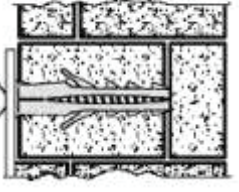
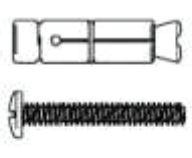
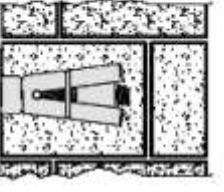
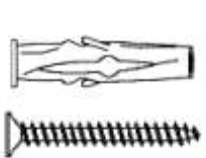
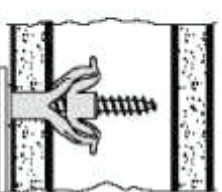
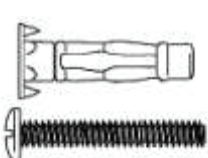
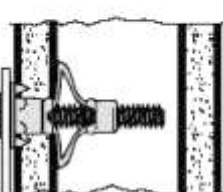

Due to the wide diversity of wall or partition types, we cannot provide you with suitable attachment fixtures. To determine which attachment fixtures to use, you will need to identify the type of wall to which you will be fixing this product. Here are some examples of attachment fixtures recommended for:

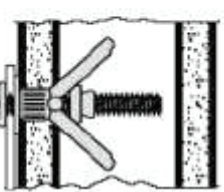

| BLIND WALLS  |   | STUDDED WALLS  |  |  |
|--|---|--|--|--|
| <p><b>"FISCHER"</b><br/>Nylon plug</p>   | <p><b>Metal</b><br/>Wall plug</p>   | <p><b>Nylon winged</b><br/>Wall plug</p>   | <p><b>Metal expansion</b><br/>plug</p>   | <p><b>"MOLLY"</b> plug</p>   |



Use a drill bit that is compatible in size with the hardware used and the type of wall.

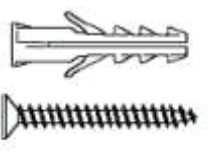
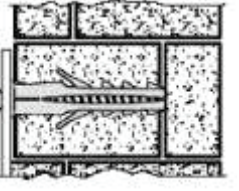
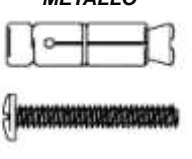
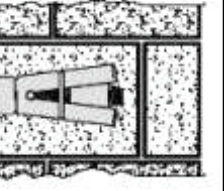
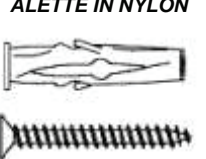
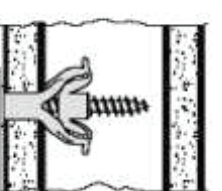
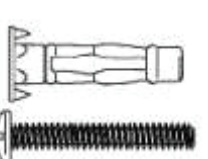
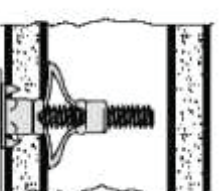

Esiste una gran varietà di tipi di muri o paratie e noi siamo in grado di fornirvi il tipo esatto di fissaggio per ognuno di essi. E' necessario identificare il tipo di parete alla quale intendete fissare questo prodotto in modo da fornirvi i fissaggi più idonei. Ecco qualche esempio di fissaggi consigliati per :

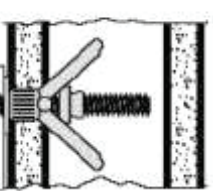
| I MURI PIENI   |   | PARATIE CAVE  |   |  |
|--|---|---|---|--|
| <p><b>TASSELLO NYLON</b><br/>"FISCHER"</p>   | <p><b>TASSELLO DI</b><br/><b>ANCORAGGIO IN</b><br/><b>METALLO</b></p>   | <p><b>TASSELLO DI</b><br/><b>ANCORAGGIO AD</b><br/><b>ALETTE IN NYLON</b></p>   | <p><b>TASSELLO METALLICO</b><br/><b>AD ESPANSIONE</b></p>   | <p><b>TASSELLO</b><br/>"MOLLY"</p>   |



Utilizzare una punta di trapano adatta agli utensili utilizzati e al tipo di muro.



Es gibt eine Vielzahl verschiedener Arten von Mauern oder Zwischenwänden, und aus diesem Grunde können wir Ihnen den genau entsprechenden Befestigungstyp nicht bereitstellen. Zunächst ist es erforderlich, die exakte Bauart der Wand zu ermitteln, an der Sie dieses Produkt anbringen werden, um die für diese Wand geeigneten Befestigungsmittel im Fachhandel erwerben zu können. Nachfolgend einige Beispiele empfohlener Befestigungen für:



**VOLLWÄNDE**

**NYLONDÜBEL  
„FISCHER“**

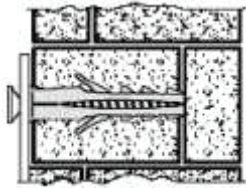
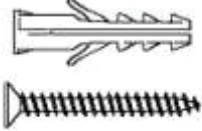

**ANKERDÜBEL  
AUS METALL**

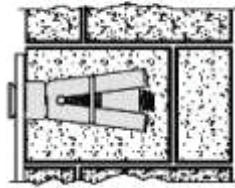
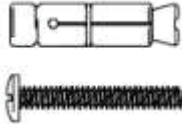

**ANKERDÜBEL MIT  
NYLONFLÜGELN**

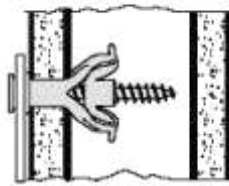
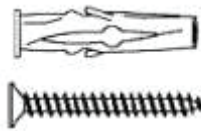

**HOHLWÄNDE**

**SPREIZDÜBEL FÜR  
VERANKERUNG AUS METALL**

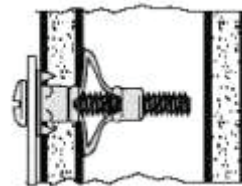
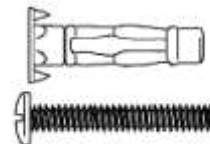

**MOLLY-DÜBEL**

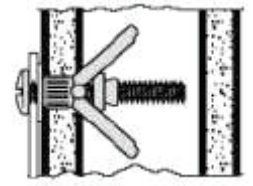

Bitte verwenden Sie eine für die Eisenwaren und den Wandtyp geeignete Bohrergröße.



Il existe une grande diversité de types de murs ou cloisons, c'est la raison pour laquelle nous ne pouvons vous fournir le type exact de fixation. Il est nécessaire d'identifier le type de paroi à laquelle vous allez fixer ce produit afin de vous procurer les fixations appropriées. Voici quelques exemples de fixations conseillées pour:



**LES MURS PLEIS**

**Cheville nylon "FISCHER"**

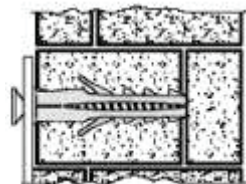
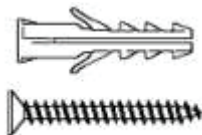

**Cheville d'ancrage métal**

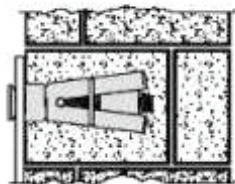

**Cheville d'ancrage  
À ailettes en nylon**

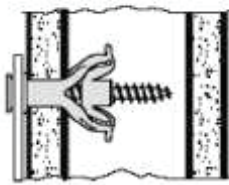
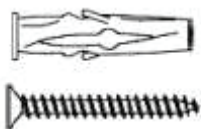

**LES CLOISONS CREUSES**

**Cheville métallique  
À expansion**

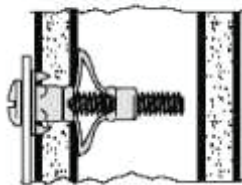
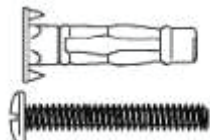

**Cheville "MOLLY"**

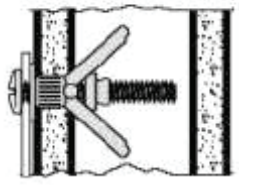

Utiliser une taille de forêt adaptée à la quincaillerie utilisée et au type de mur.



15

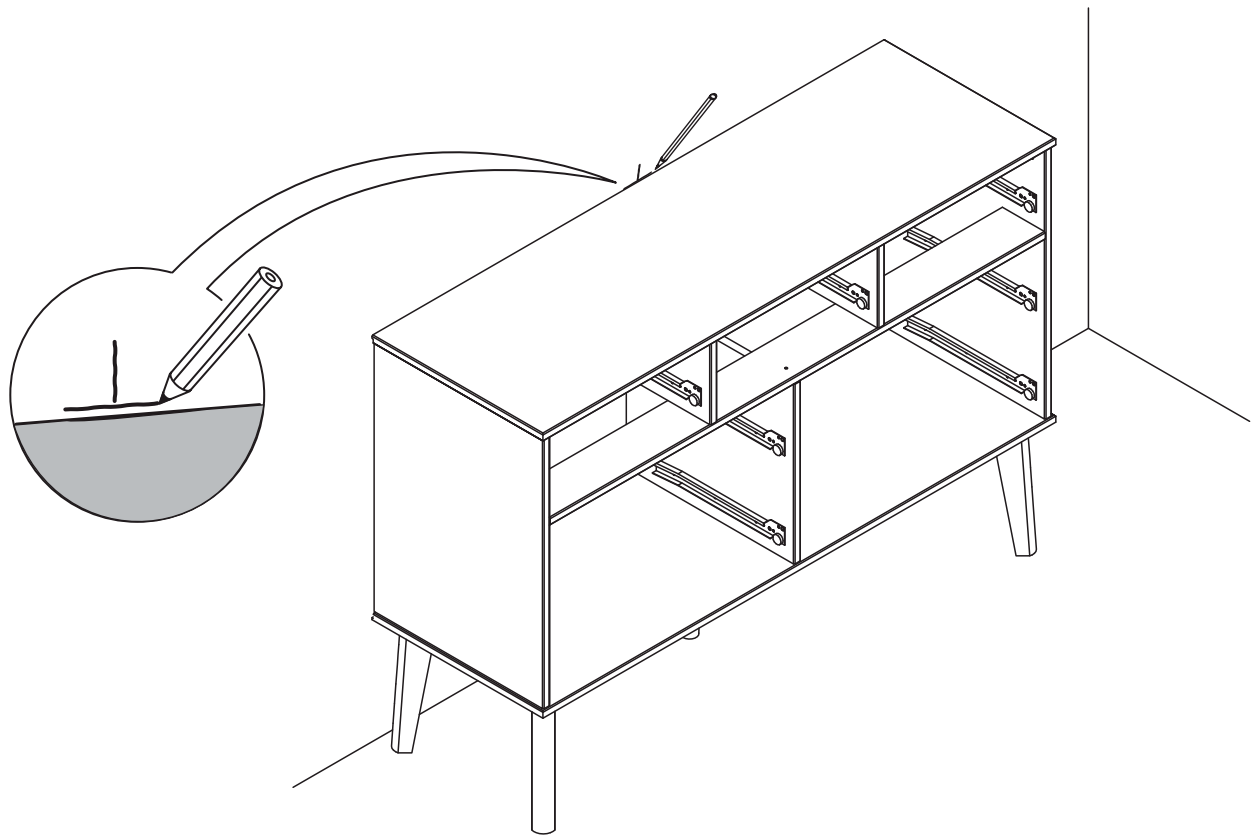

16



FIXATION MURALE OBLIGATORIE  
OBLIGATORIO FIJAR A LA PARED  
OBLIGATORY FIX ON THE WALL

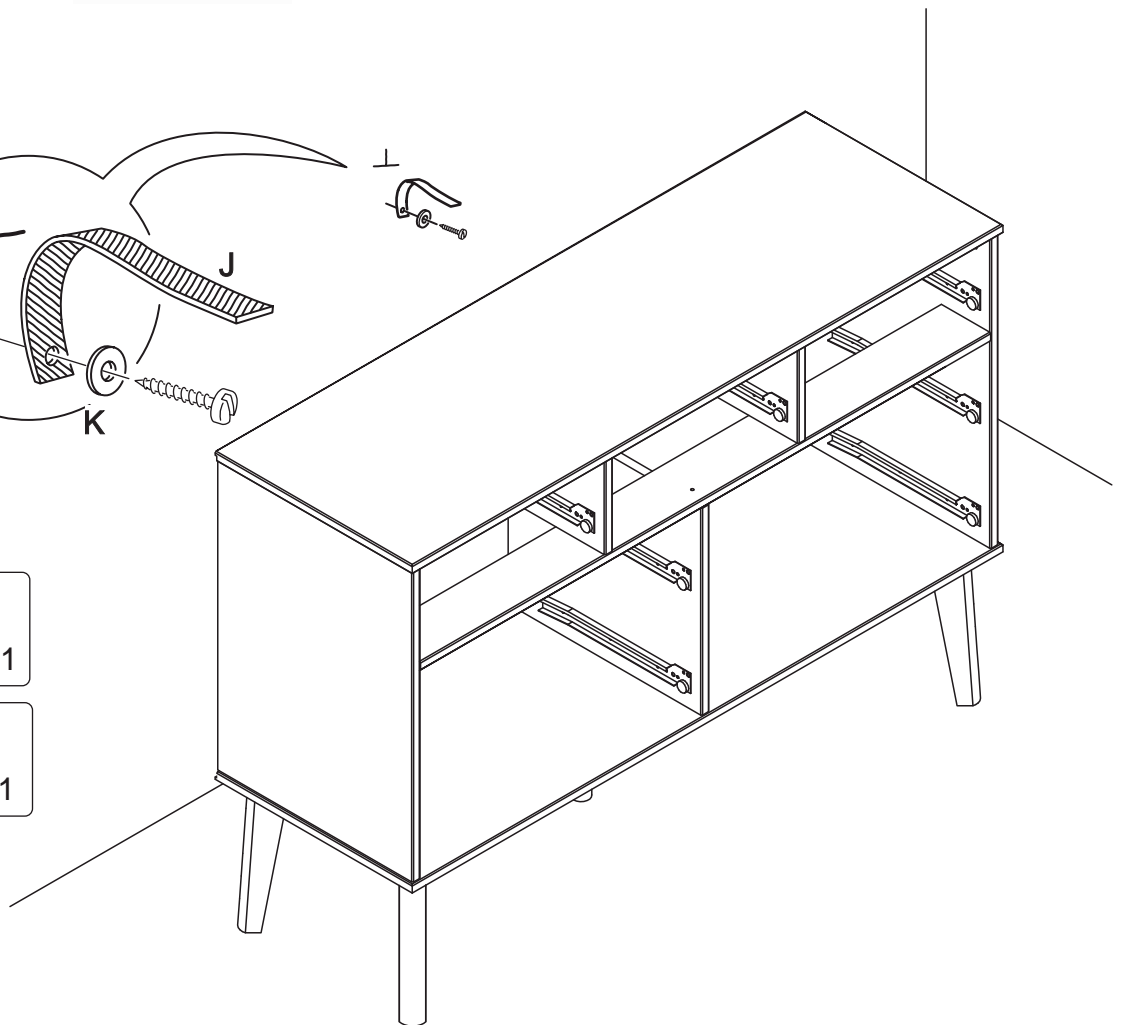
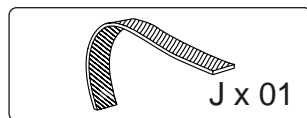
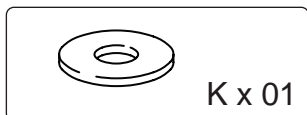
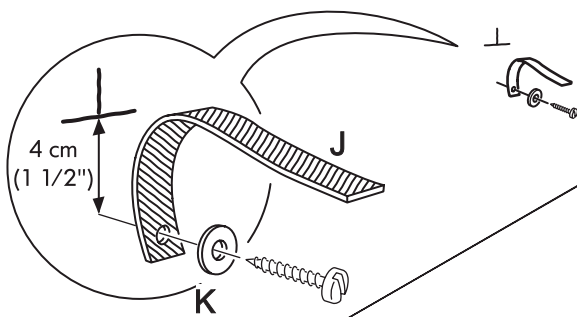

17

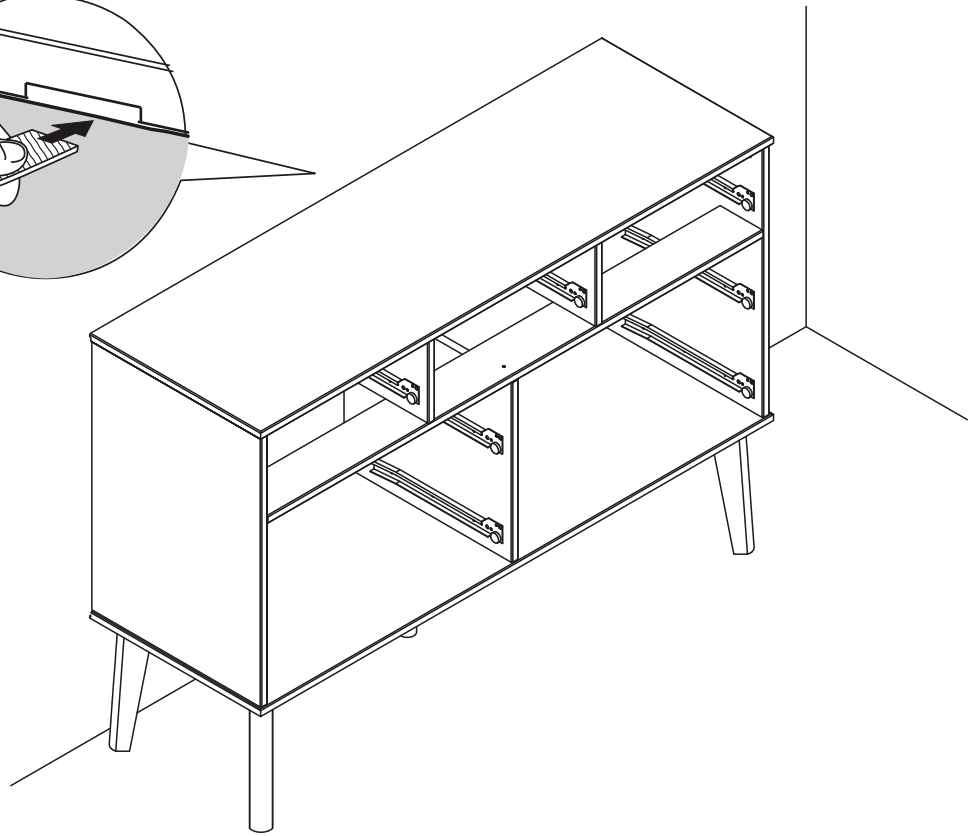
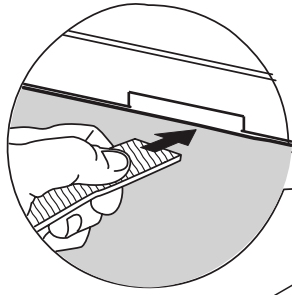

18

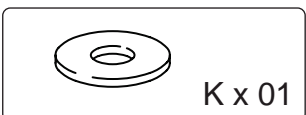
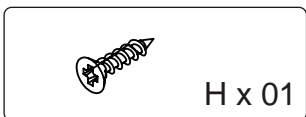
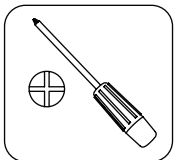
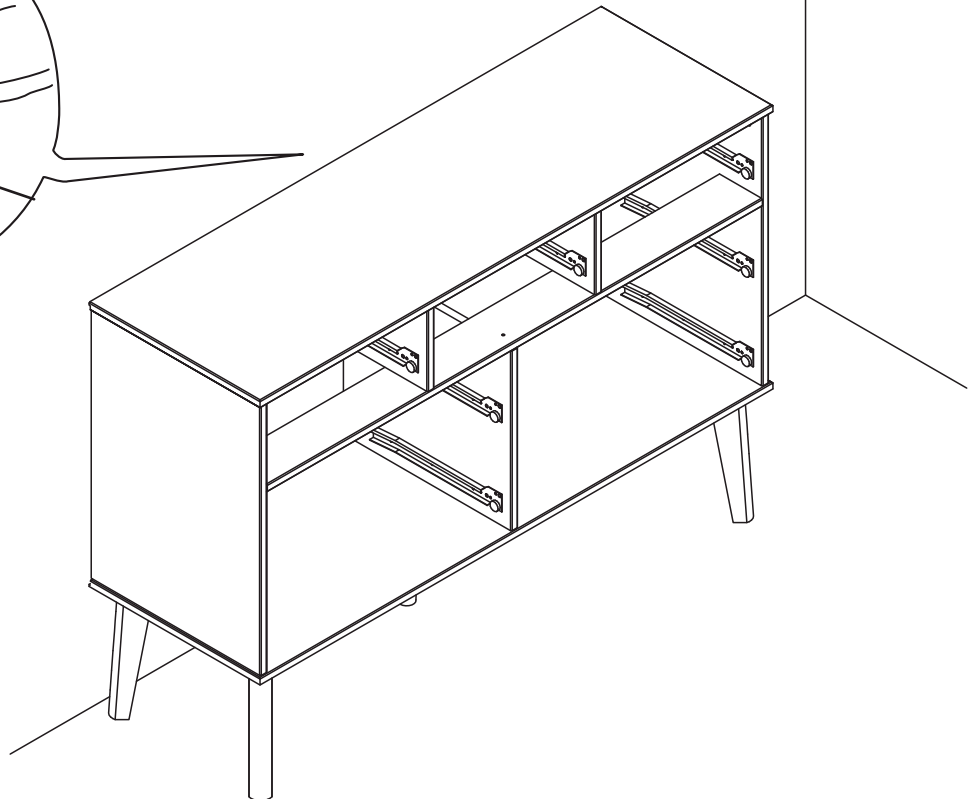
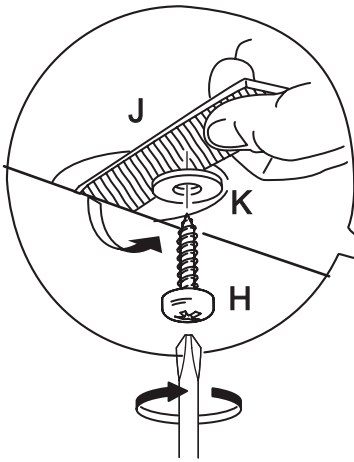

19

3x

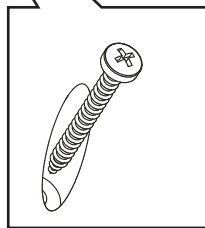
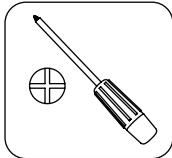
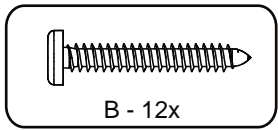
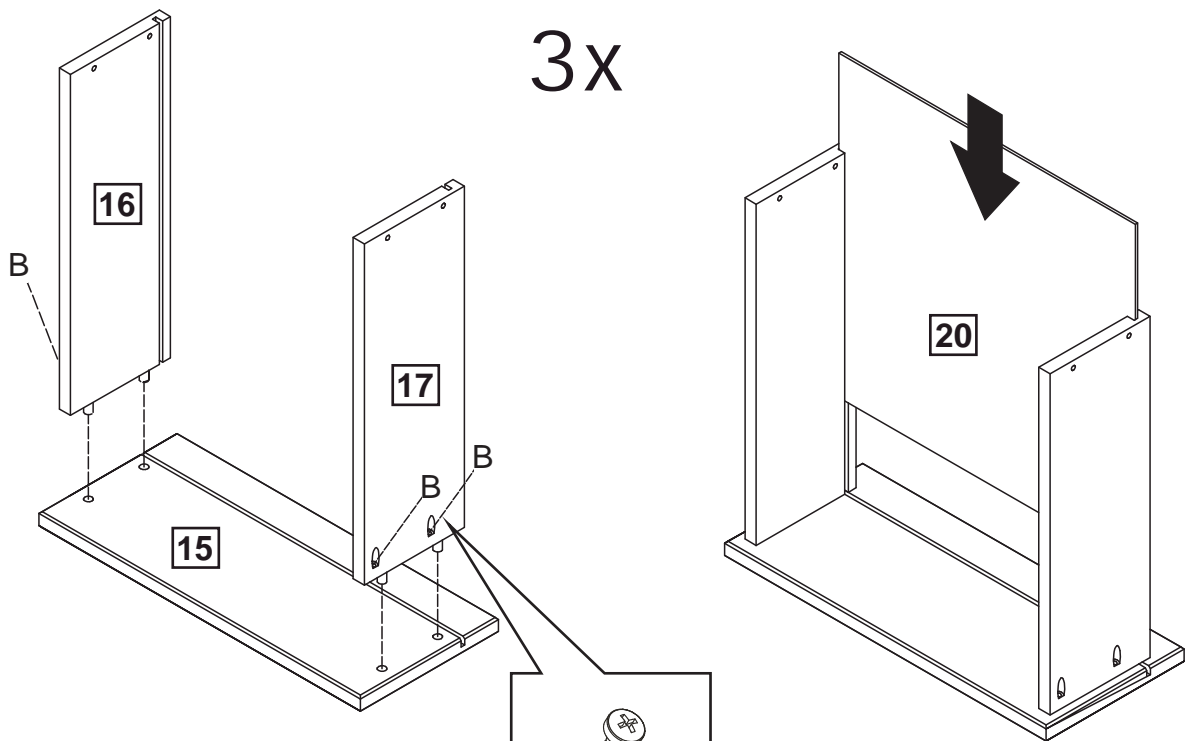

20

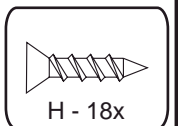
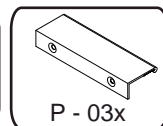
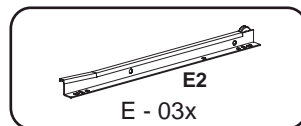
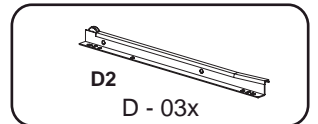
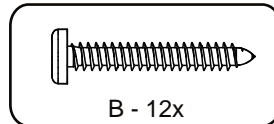
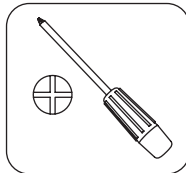
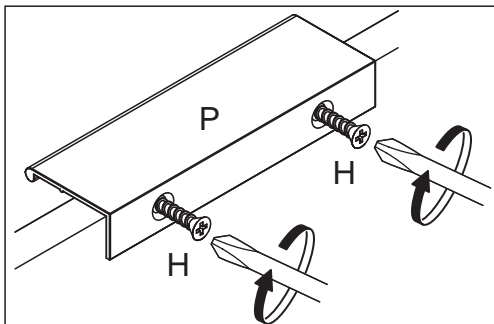

3x

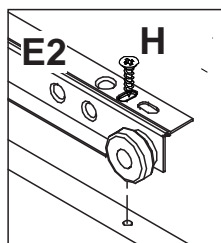
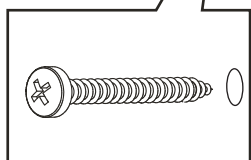
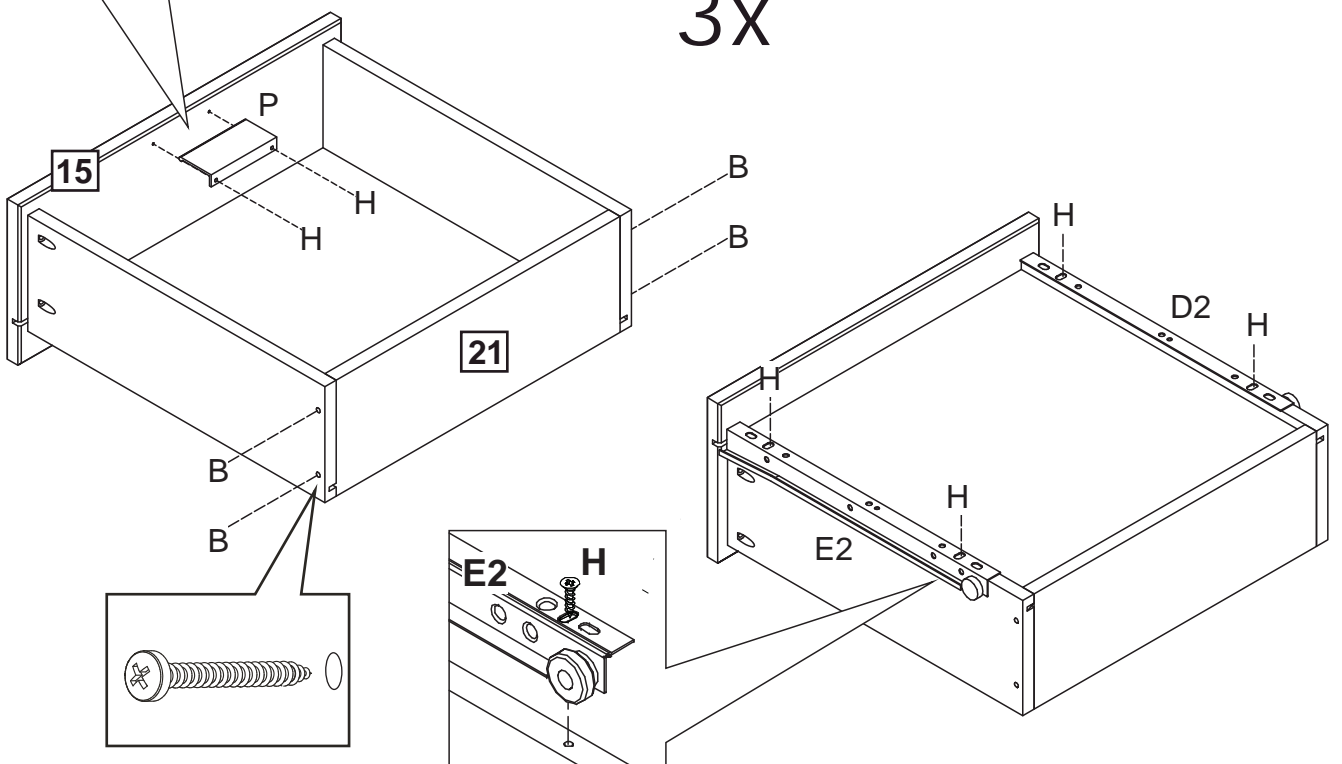

21

4x

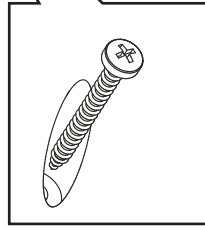
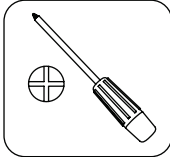
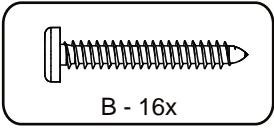
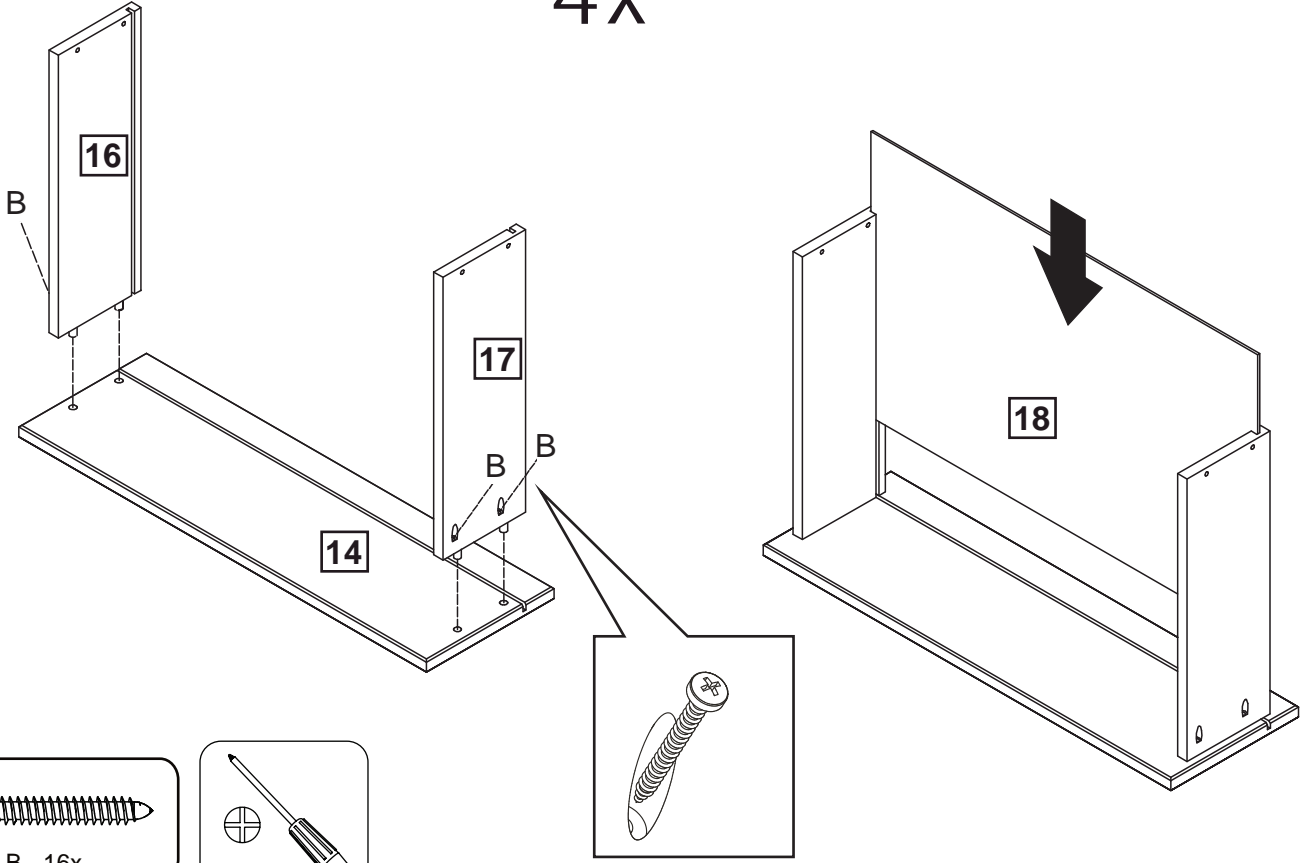

22

4x

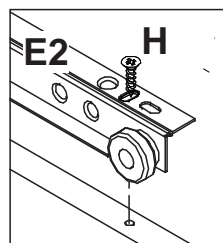
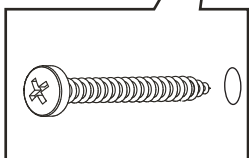
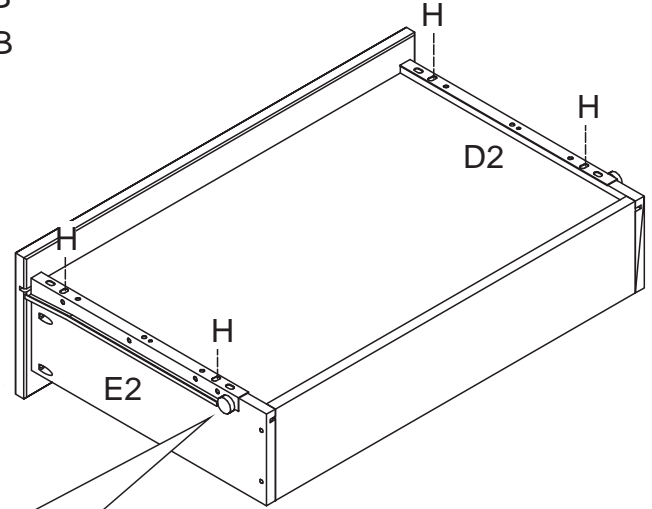
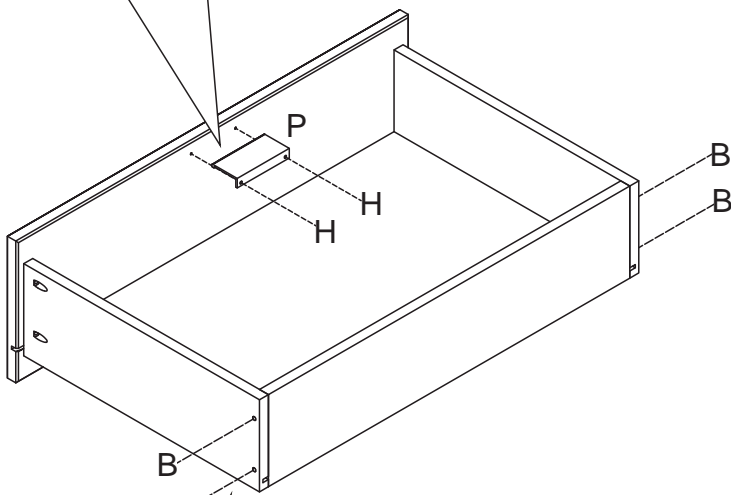
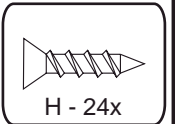
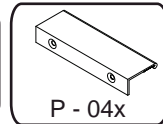
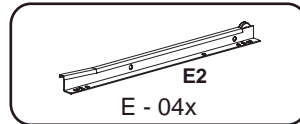
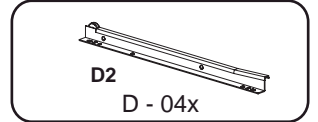
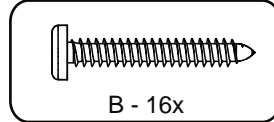
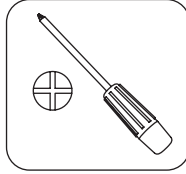
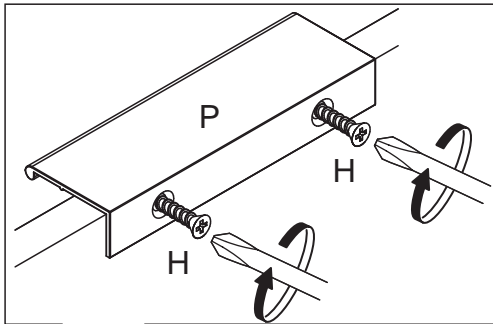

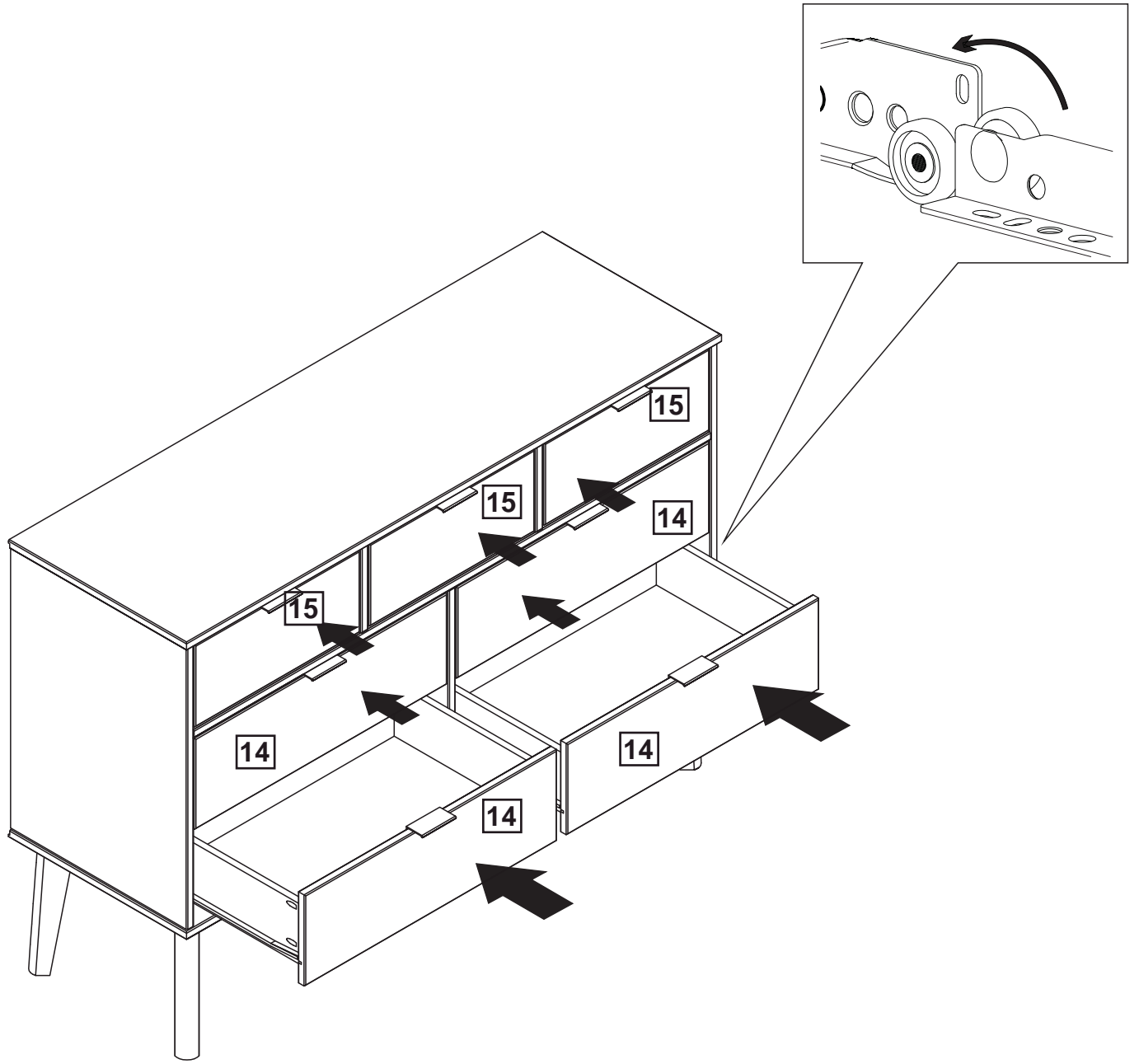

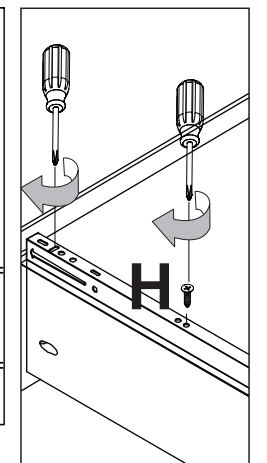
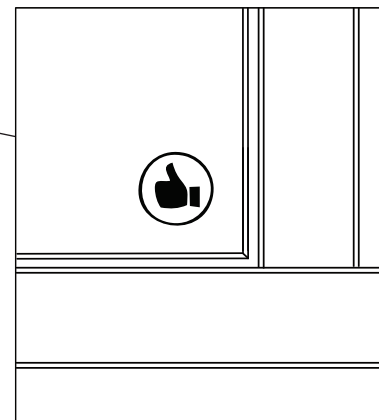
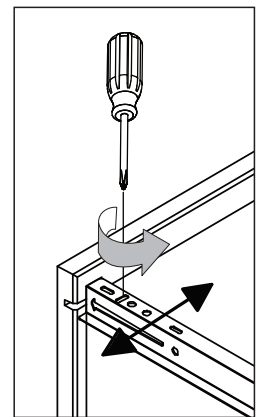
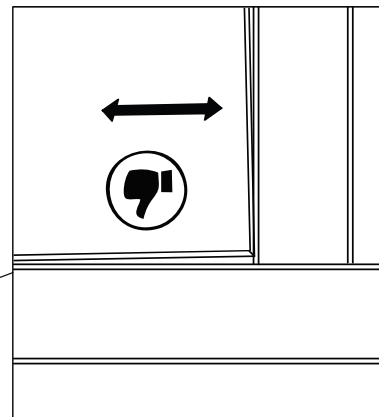
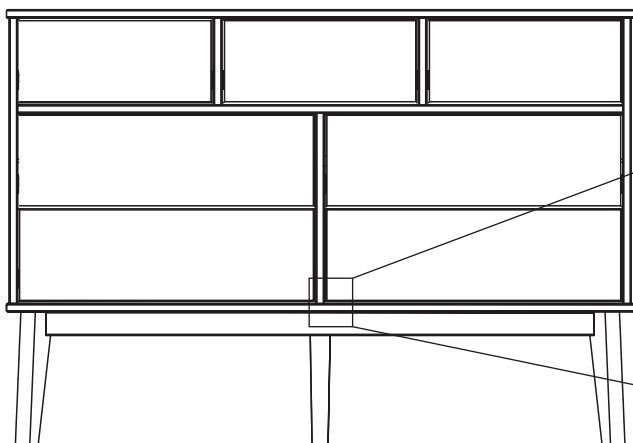
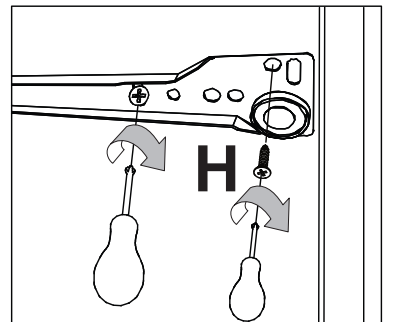
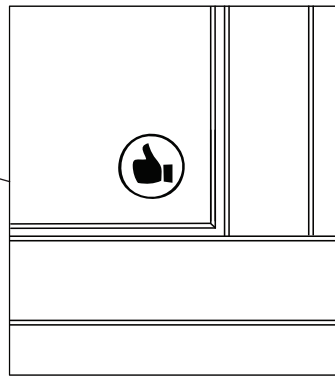
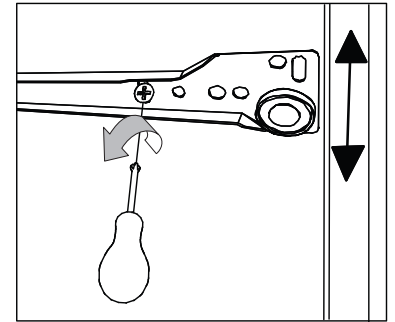
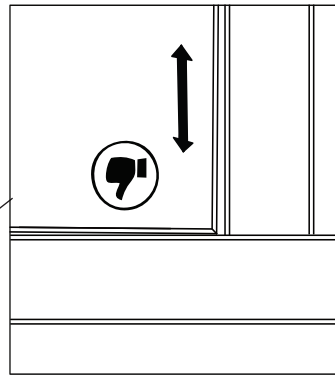
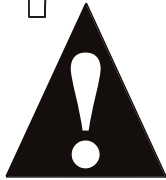
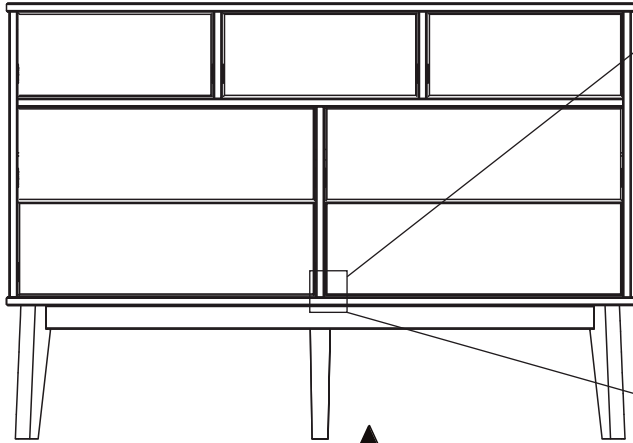
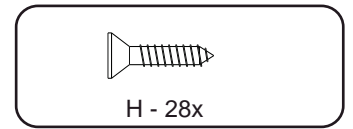
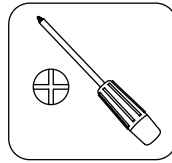

FRENCH: "Les meubles contenant des panneaux à base de bois (panneaux de particules, panneaux de fibres, contreplaqué...) peuvent émettre des substances polluantes dans l'air intérieur. Il est ainsi recommandé, après l'installation du meuble dans son logement, d'aérer fréquemment la pièce concernée pendant au moins quatre semaines afin de réduire son exposition aux polluants émis par le meuble."

SPANISH: Los muebles que contienen paneles a base de madera (Aglomerado, cartón, contrachapado ...) pueden emitir sustancias contaminantes en el aire. Por lo tanto, se recomienda airear frecuentemente los muebles al menos durante cuatro semanas después de su instalación para reducir su exposición a los contaminantes emitidos por los muebles.

ENGLISH: Furniture containing wood-based panels (Particle board, fibreboard, plywood ...) could emit pollutants on the air. Therefore, it is advisable to ventilate the furniture at least during four weeks after its assembly in order to reduce the exposure to the pollutants released by the furniture.

## FRANCAIS - SUISSE

### CONSEILS DE MONTAGE :

- 1 > BIEN ETUDIER LA NOTICE DE MONTAGE.
- 2 > REPEREZ LES PIECES CONSTITUANT VOTRE MEUBLE.
- 3 > REGROUPEZ ET CONTROLEZ LA QUINCAILLERIE.
- 4 > MUNISSEZ-VOUS DE L'OUTILLAGE NECESSAIRE.
- 5 > AMENAGEZ-VOUS UNE ZONE DE MONTAGE.
- 6 > PROCEDEZ AU MONTAGE.



**NE JAMAIS FORCER LES ASSEMBLAGES.  
RESSERREZ LES VIS APRES QUELQUES TEMPS D'USAGE.  
GARDER VOTRE NOTICE DE MONTAGE, SI UNE PIECE  
VENAIT A MANQUER, ELLE SERAIT LE PLUS CLAIR  
MOYEN DE COMMUNIQUER AVEC VOTRE MAGASIN.**

### CONSEILS D'ENTRETIEN :

- 1 > DÉPOUSSIÉREZ SOIGNEUSEMENT.
- 2 > UTILISEZ UN CHIFFON SEC.



**- NE JAMAIS UTILISER  
DE PRODUITS ABRASIFS:  
POUDRE, LAINE D'ACIER, SOLVANTS.  
- NE PAS MOUILLER**

|                                | PAPIER<br>DECOR | SURFACES<br>STRATIFIÉES | SURFACES<br>LAQUÉES | BOIS<br>VERNIS | TEXTILE<br>CUIR |
|--------------------------------|-----------------|-------------------------|---------------------|----------------|-----------------|
| EAU SAVONNEUSE (SAVON NEUTRE)  | ○               | ○                       | ○                   | ○              | ○               |
| EAU ADDITIO NÉE                |                 | ○                       | ○                   |                |                 |
| ENTRETIEN SPÉCIFIQUE FABRICANT |                 |                         |                     |                | ○               |

## DEUTSCH - SCHWEIZ

### MONTAGE ANLEITUNG:

- 1 > DIE MONTAGEANLEITUNG SORGFÄLTIG DURCHLESEN.
- 2 > DIE EINZELTEILE DES MÖBELSTÜCKS ERMITTELN.
- 3 > DIE BESCHLÄGE ZUSAMMENLEGEN UND PRÜFEN.
- 4 > DAS NOTWENDIGE WERKZEUG ZURECHTLEGEN.
- 5 > EINEN MONTAGEBEREICH FREIMACHEN.
- 6 > DAS MÖBELSTÜCK ZUSAMMENBAUEN.



**NIEMALS DIE VERBINDUNGEN ZU STARK ANZIEHEN.  
DIE SCHRAUBEN NACH EINIGER ZEIT DES GEBRAUCHS  
ERNEUT FESTZIEHEN. DIE MONTAGEANLEITUNG  
GUT AUFBEWAHREN: SOLLTE EIN TEIL FEHLEN, IST SIE DAS  
BESTE VERSTÄNDIGUNGSMITTEL MIT IHREM GESCHÄFT.**

### PFLEGEHINWEISE :

- 1 > SORGFÄLTIG ENTSTAUBEN.
- 2 > VERWENDEN SIE EIN TROCKENES TUCH.



**- BENUTZEN SIE KEINE  
SCHEUERMITTEL WIE PULVER,  
STAHLWOLLE, LÖSUNGSMITTEL.  
- KEIN WASSER VERWENDEN.**

|                                  | DEKORPAPIER | OBERFLÄCHE<br>LAMINAT | OBERFLÄCHE<br>LACK | LACKIERTEM<br>HOLZ | TEXUL<br>LEDER |
|----------------------------------|-------------|-----------------------|--------------------|--------------------|----------------|
| SEIFENLAUGE (NEUTRALSEIFE)       | ○           | ○                     | ○                  | ○                  | ○              |
| WASSER MIT HAUSHALTSRFINGIGER    |             | ○                     | ○                  |                    |                |
| PRODUZENT SPEZIFISCHER UNTERHALT |             |                       |                    |                    | ○              |

## ITALIANO - SVIZZERA

### CONSIGLI DI MONTAGGIO

- 1 > STUDIARE BENE LE ISTRUZIONI DI MONTAGGIO.
- 2 > PRENDERE CONOSCENZA DEI PEZZI CHE COSTITUISCONO IL MOBILE.
- 3 > RAGGRUPPARE E CONTROLLARE LA FERRAMENTA.
- 4 > MUNIRSI DEGLI UTENSILI NECESSARI.
- 5 > PREPARARE UNA ZONA DI MONTAGGIO.
- 6 > PROCEDERE AL MONTAGGIO.



**NON FORZARE MAI GLI ASSEMBLAGGI  
RISTRINGERE LE VITI DOPO UN PERIODO D'USO  
CONSERVARE QUESTE ISTRUZIONI DI MONTAGGIO,  
SE UN PEZZO VENISSE A MANCARE SAREBBE IL MIGLIORE  
MEZZO DI COMUNICAZIONE CON IL RIVENDITORE**

### CONSIGLI PER LA MANUTENZIONE :

- 1 > SPOLVERATE ACCURATAMENLE.
- 2 > USARE UN PANNINO ASCIUTTO.



**- NON UTILIZZARE MAI PRODOTTI  
ABRASIVI: POLVERE,  
LANA DI ACCIAIO, SOLVENTI.  
- NON BAGNARE.**

|                                   | CARTA | SUPERFICIE<br>STRATIFICATE | SUPERFICIE<br>LACCATE | LACCATE EGNO<br>VERNICIATO | TESSILE<br>CUOIO |
|-----------------------------------|-------|----------------------------|-----------------------|----------------------------|------------------|
| ACQUA CON SAPONE (SAPONE NEUTRO)  | ○     | ○                          | ○                     | ○                          | ○                |
| ACQUA CON DETERSIVO SAN MARC      |       | ○                          | ○                     |                            |                  |
| MANUTENZIONE SPECIFICA PRODUTTORE |       |                            |                       |                            | ○                |



## PORTUGUÊS

### CONSELHOS DE MONTAGEM:

- 1 > ESTUDE BEM AS INSTRUÇÕES DE MONTAGEM.
- 2 > REUNA AS PEÇAS QUE CONSTITUEM O SEU MÓVEL.
- 3 > REAGRUPE AS FERRAGENS.
- 4 > EQUIPE-SE COM AS FERRAMENTAS NECESSÁRIAS.
- 5 > PREPARE UMA ÁREA PARA A MONTAGEM.
- 6 > INICIE A MONTAGEM.



**NUNCA FORÇAR OS ENCAIXES.**  
**REAPERTAR OS PARAFUSOS APÓS UM TEMPO DE UTILIZAÇÃO.**  
**GUARDAR AS INSTRUÇÕES DE MONTAGEM.**  
**CASO FALTE ALGUMA PEÇA, O MAIS ACONSELHÁVEL É CONTATAR O REVENDEDOR.**

### CONSELHOS PARA A MANUTENÇÃO :

- 1 > ELIMINAR BEM O PÓ.
- 2 > USAR PANO SECO.



**- NUNCA UTILIZAR PRODUTOS ABRASIVOS: SAPONÁCEOS, LÃ DE AÇO, SOLVENTES.**  
**- NÃO MOLHAR .**

|                                      | ACABAMENTO IMITAÇÃO | SUPERFÍCIES ESTRATIFICADAS | SUPERFÍCIES LACADAS | MADEIRA ENVERNIZADA | TEXTEIS PELES |
|--------------------------------------|---------------------|----------------------------|---------------------|---------------------|---------------|
| ÁGUA COM SABÃO (SABÃO NEUTRO)        | ○                   | ○                          | ○                   | ○                   | ○             |
| ÁGUA COM DETERGENTE                  |                     | ○                          | ○                   |                     |               |
| INSTRUÇÕES ESPECÍFICAS DO FABRICANTE |                     |                            |                     |                     | ○             |

## ESPAÑOL

### CONSEJOS PARA EL MONTAJE:

- 1 > ESTUDIE ATENTAMENTE EL MANUAL DE MONTAJE.
- 2 > LOCALICE LAS PIEZAS QUE CONSTITUYEN SU MUEBLE.
- 3 > REUNA Y CONTROLE LOS TORNILLOS.
- 4 > EQUIPE-SE DE LAS HERRAMIENTAS NECESARIAS.
- 5 > PREPARE UNA ZONA DE MONTAJE.
- 6 > REALICE EL MONTAJE.



**NO FUERCE NUNCA EN LAS UNIONES. APRIETE LOS TORNILLOS DESPUES DE CIERTO TIEMPO DE UTILIZACION**  
**CONSERVE SU MANUAL DE MONTAJE,**  
**SI FALTARA UNA PIEZA, SERIA LA MANERA MAS FACIL DE COMUNICAR CON LA TIENDA.**

### CONSEJOS PARA EL MANTENIMIENTO:

- 1 > DESPOLVOREAR CULDADOSAMENTE.
- 2 > UTILICE UN PAÑO SECO.



**- NO USE NUNCA PRODUCTOS ABRASIVOS TALES COMO: POLVO DE LIMPIAR, LANA DE ACERO, SOLVENTES.**  
**- NO MOJAR.**

|   | PAPEL DE DECORACION | SUPERFICIE ESTRATIFICADAS | SUPERFICIE MAQUEADAS | MADERA BARNIZADA | TEXULL CUERO |
|---|---------------------|---------------------------|----------------------|------------------|--------------|
| AGUA Y JABON (JABON NEUTRO)             | ○                   | ○                         | ○                    | ○                | ○            |
| AGUA COM DETERGENTE                     |                     | ○                         | ○                    |                  |              |
| MANTENIMIENTO ESPECIFICO DEL FABRICANTE |                     |                           |                      |                  | ○            |

## HRVATSKA

### UPUTE ZA MONTAŽU:

- 1 > PAŽLJIVO PROČITAJTE UPUTE ZA MONTAŽU.
- 2 > PRIPREMITE SVE DIJELOVE NAMJEŠTAJA.
- 3 > PRIKUPITE I PROVJERITE OKOVE ZA MONTAŽU.
- 4 > PRIPREMITE POTREBAN ALAT.
- 5 > PRIPREMITE PROSTOR ZA MONTAŽU.
- 6 > POČNITE MONTIRATI.



**NEMOJTE UPOTREBLJAVATI SILU PRILIKOM SKLAPANJA**  
**NAKON NEKOG VREMENA PONOVRNO PRITEGNITE VIJKE**  
**ČUVAJTE UPUTE ZA MONTAŽU**  
**U SLUČAJU NEDOSTATKA NEKOG DIJELA NAJBOLJE ĆE BITI DA DA KONTAKIRATE PRODAJNO MJESTO.**

### UPUTE ZA ODRŽAVANJE :

- 1 > PAŽLJIVO OBRISATI PRAŠINU.
- 2 > KORISTITE SUHU KRPU.



**- ZABRANJENA JE UPOTREBA KEMIKALIJA ILI BILO KAKVIH POMOĆNIH SREDSTAVA ZA RIBANJE JAKIH SREDSTAVA ZA ČIŠĆENJE ILI ČELIČNE VUNE**  
**-NE MOKRA.**

|                    | PAPIR | LAMINAT | LAK | DRVO | TEKSTIL/ KOŽA |
|--------------------|-------|---------|-----|------|---------------|
| OTPINA SAPUNA      | ○     | ○       | ○   | ○    | ○             |
| OTPINA DETERDŽENTA |       | ○       | ○   |      |               |
| NAMJENSKA SREDSTVA |       |         |     |      | ○             |

## TÜRÇE

### MONTAJ TALIMATLARI:

- 1 > MONTAJ TANITIM YAZISINI DIKKATLICE OKUYUNUZ .
- 2 > MOBILİYANIZI OLUŞTURAN PARÇALARI İŞARETLEYİNİZ.
- 3 > HIRDAVATLA İLGİLİ PARÇALARI BİR ARAYA TOPLAYIP; KONTROL EDİNİZ.
- 4 > GEREKEN ARAÇ VE GEREÇİ TEDARİK EDİNİZ.
- 5 > (KENDİNİZE) BİR MONTAJ ALANI EDİNİNİZ.
- 6 > MONTE ETMEYE BAŞLAYINIZ.



**MONTAJLARI ZORLAMAYINIZ.  
BİRKAÇ KULLANIMDAN SONRA VIDALARI SIKIŞTIRINIZ.  
BİR PARÇANIN KAYBOLMASI DURUMUNDA MAGAZANIZLADAHAKOLAY İLETİŞİME GEÇEBİLMEZİNİZ İÇİN MONTAJ KULLANIM TALİMATINIZI SAKLAYINIZ.**

### BAKIM TALIMATLARI:

- 1 > TOZUNU DIKKATLICE ALINIZ.
- 2 > YUMUŞAK BİR BEZİ TEMİZ SU VE AZ MİKTARDA SABUNLA(DETERJAN) NEMLENDİRİNİZ.



**ASLA AŞINDIRICI ÜRÜNLER KULLANMAYINIZ : ÇELİK YÜNÜ, SOLVENT... BOL SUYLA YIKAMAYINIZ.**

|                         | SÜS KAGIDI            | KATMAN YÜZEY          | LAKE YÜZEY            | CILALI TAHTA          | TEKSTİL DERİ          |
|-------------------------|-----------------------|-----------------------|-----------------------|-----------------------|-----------------------|
| SABUNLU SU (NOTR SABUN) | <input type="radio"/> | <input type="radio"/> | <input type="radio"/> | <input type="radio"/> | <input type="radio"/> |
| DETERJAN KATILMIŞ SU    |                       | <input type="radio"/> | <input type="radio"/> |                       |                       |
| ÜRETİCİYE ÖZGÜ BAKIM    |                       |                       |                       |                       | <input type="radio"/> |

## ENGLISH

### ASSEMBLY ADVICE :

- 1 > CAREFULLY READ THE ASSEMBLY INSTRUCTION.
- 2 > IDENTIFY THE COMPONENTS OF THE FURNITURE.
- 3 > GROUP AND CHECK THE HARDWARE.
- 4 > USE THE REQUIRED TOOLS.
- 5 > CREATE AN ASSEMBLY ZONE.
- 6 > MAKE THE ASSEMBLY.



**NEVER FORCE THE CONNECTIONS.  
RE-TIGHTEN THE SCREWS AFTER FEW DAYS.  
PLEASE RETAIN THE AI LEAFLET FOR FUTURE REFERENCE,  
THE AI CONTAINS INFORMATION WHEN CLAIMING FOR MISSING PARTS.**

### CLEANING ADVICE:

- 1 > CAREFULLY REMOVE THE DUST.
- 2 > USE A SOFT, CLEAN DAMP CLOTH WITH SOAPY WATER.



**NEVER USE ABRASIVE PRODUCTS OR SOLVENTS.  
DO NOT APPLY EXCESSIVE PRESSURE WHEN USING THE DAMP CLOTH.**

|                            | PAPER DECOR           | LAMINATED SURFACES    | LACQUERED SURFACE     | VARNISHED WOOD        | LEATHER TEXTILE       |
|----------------------------|-----------------------|-----------------------|-----------------------|-----------------------|-----------------------|
| SOAPY WATER (NEUTRAL SOAP) | <input type="radio"/> | <input type="radio"/> | <input type="radio"/> | <input type="radio"/> | <input type="radio"/> |
| WATER WITH DETERGENT       |                       | <input type="radio"/> | <input type="radio"/> |                       |                       |
| SPECIFIC SUPPLIER CLEANING |                       |                       |                       |                       | <input type="radio"/> |



**LE TRI  
+ FACILE**



FR

Donnez ou recyclez vos meubles.



ou



ou



<https://quefairedemesdechets.fr>