

ATTACHMENT
LIST

Pacific Home

ATTACHMENT
LIST

ONLY BOOK SHELF

BOOKSHELF





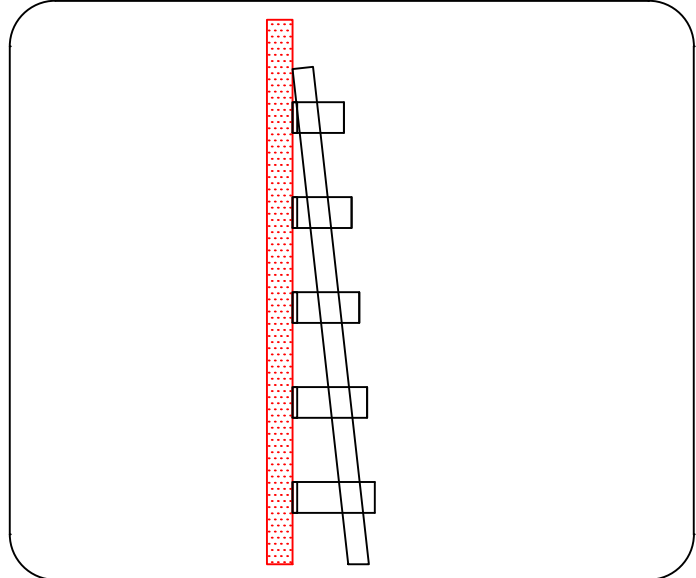

PRODUCT CODE 32TRZ-ONLY
KTPLK 0001



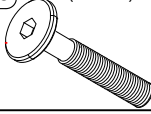

PACKING CODE:

1. ST-ONLY KİTAPLIK 1-(2)
2. ST-ONLY KİTAPLIK 2-(2)

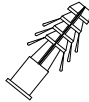

ATTACHMENTS

NAME	DOWEL 8*35	MINIFIX BODY	MINIFIX MILE	MINIFIX TAPA	CYLINDRICAL PICKING PART (30 mm)	KEY SWITCH OF 5 PER
SHAPE	001 	002 	003 	006 	219 	421 
TOTAL	30	45	45	45	20	1

NAME	RECOMMENDED TO THE WALL				
	3.5*18 SCREW	WALL MOUNTED	FOR WALL 3.5*35 SREW	M 6 STAMP	CONNECTION CHAIN
SHAPE	161 	045 	163 	214 	018 
TOTAL	1	1	1	2	1

NAME					
SHAPE					
TOTAL					

NAME					
SHAPE					
TOTAL					

ONLY BOOK SHELF

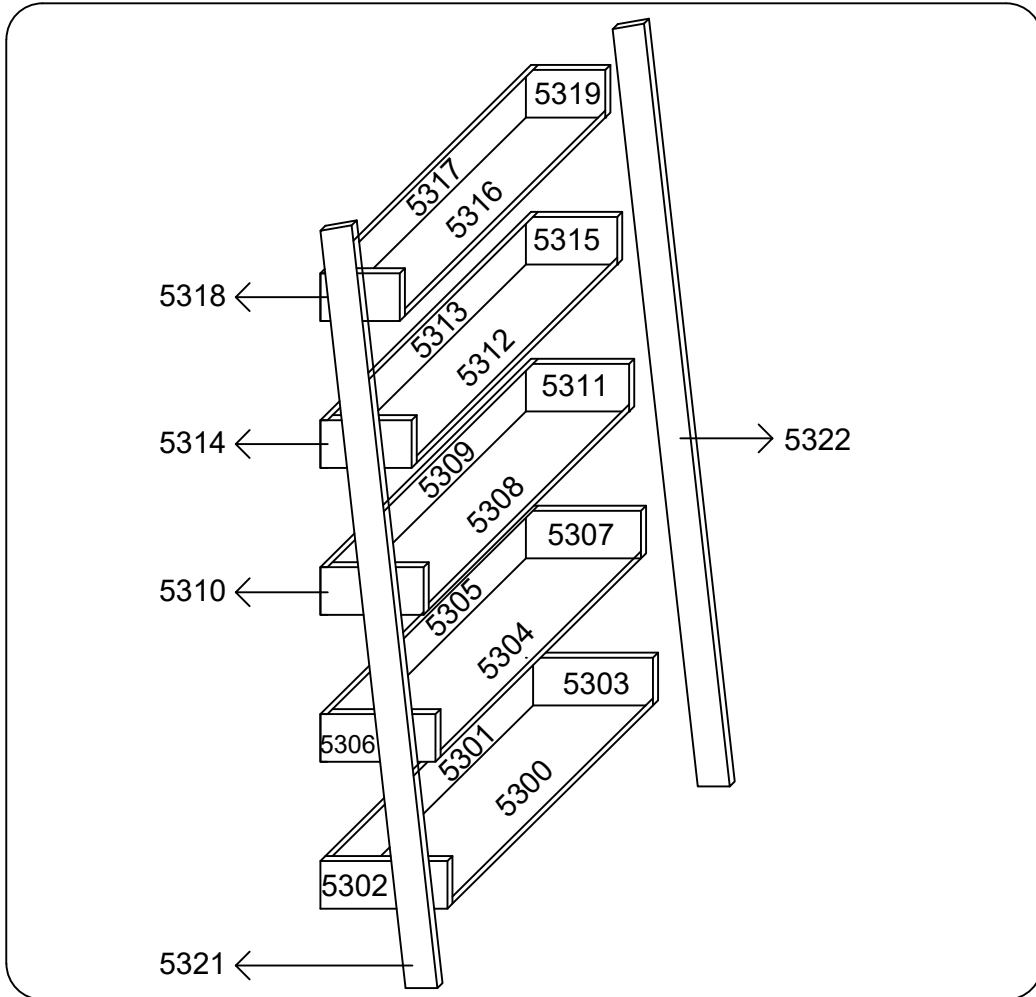

COMPONENT		
CODE	NAME	TOTAL
5300	MODUL 1 LOWER PANEL	1
5301	MODUL 1 BACK PANEL	1
5302	MODUL 1 LEFT PANEL	1
5303	MODUL 1 RIGHT YAN PANEL	1
5304	MODUL 2 LOWER PANEL	1
5305	MODUL 2 BACK PANEL	1
5306	MODUL 2 LEFT YAN PANEL	1
5307	MODUL 2 RIGHT SIDE PANEL	1
5308	MODUL 3 LOWER PANEL	1
5309	MODUL 3 BACK PANEL	1
5310	MODUL 3 LEFT SIDE PANEL	1
5311	MODUL 3 RIGHT SIDE PANEL	1

COMPONENT		
CODE	NAME	TOTAL
5312	MODUL 4 LOWER PANEL	1
5313	MODUL 4 BACK PANEL	1
5314	MODUL 4 LEFT SIDE PANEL	1
5315	MODUL 4 RIGHT SIDE PANEL	1
5316	MODUL 5 LOWER PANEL	1
5317	MODUL 5 BACK PANEL	1
5318	MODUL 5 LEFT SIDE PANEL	1
5319	MODUL 5 RIGHT SIDE PANEL	1
5321	LEFT STAND PANEL	1
5322	RIGHT STAND PANEL	1

ONLY BOOKSHELF

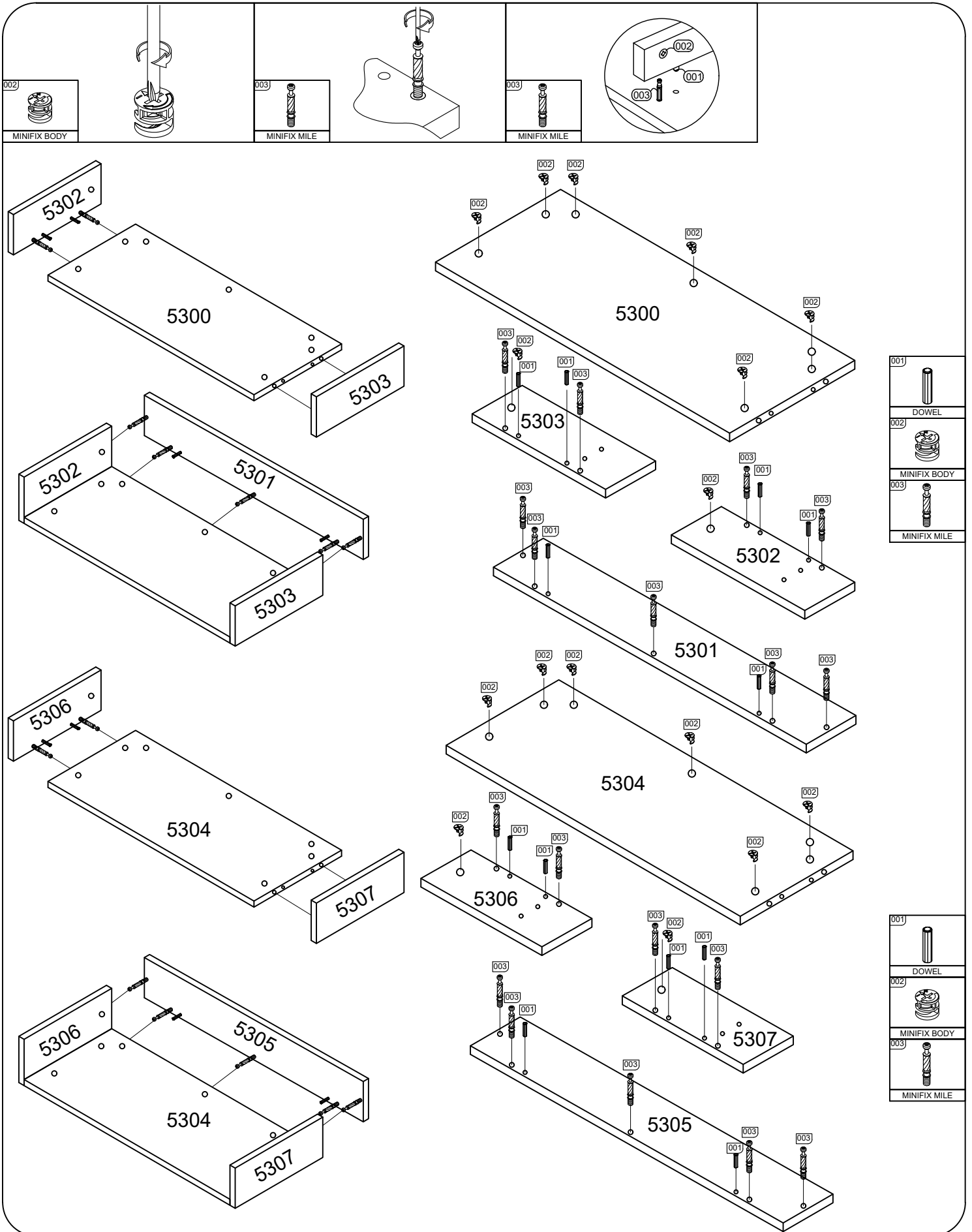

ONLY BOOKSHELF

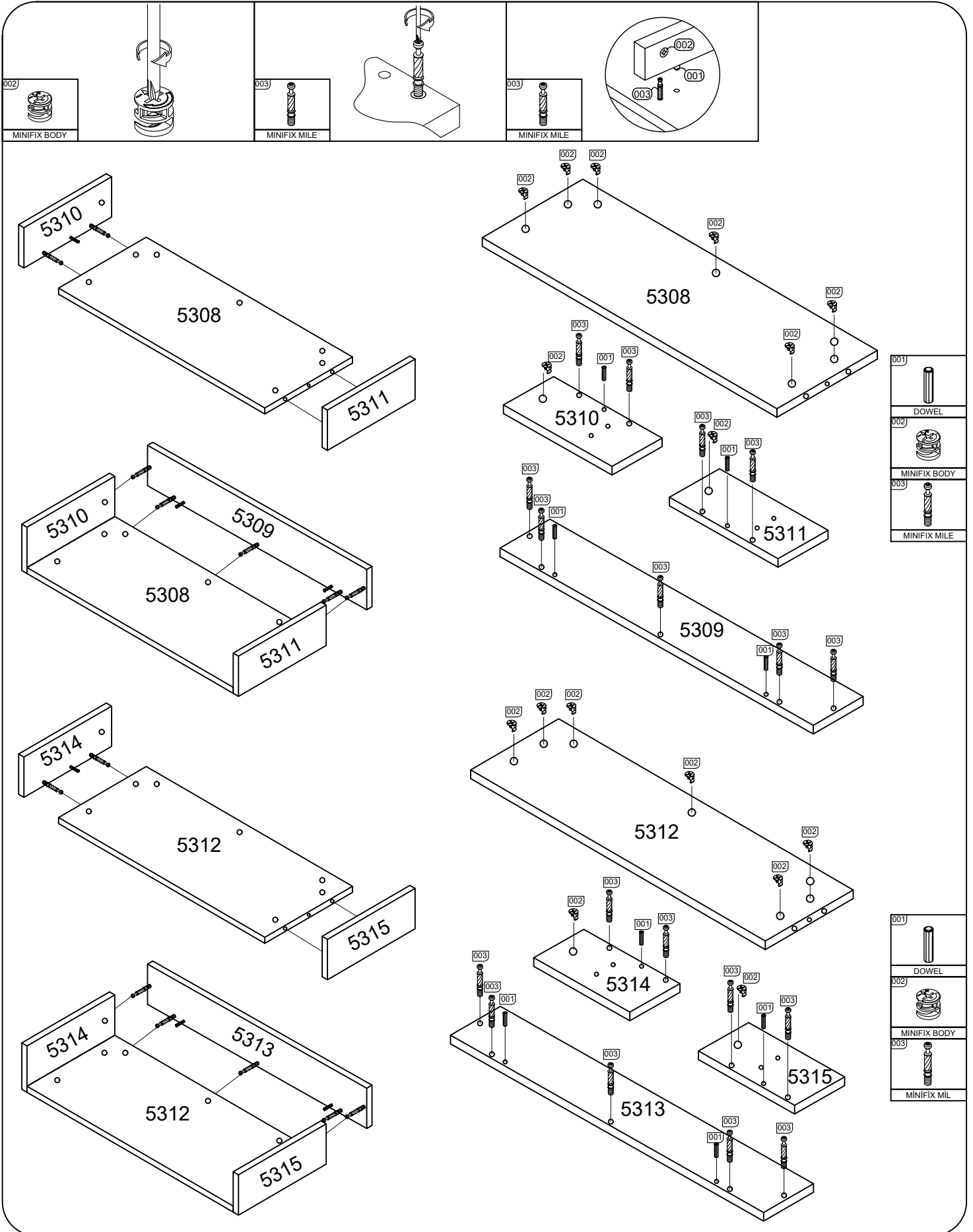

ONLY BOOKSHELF

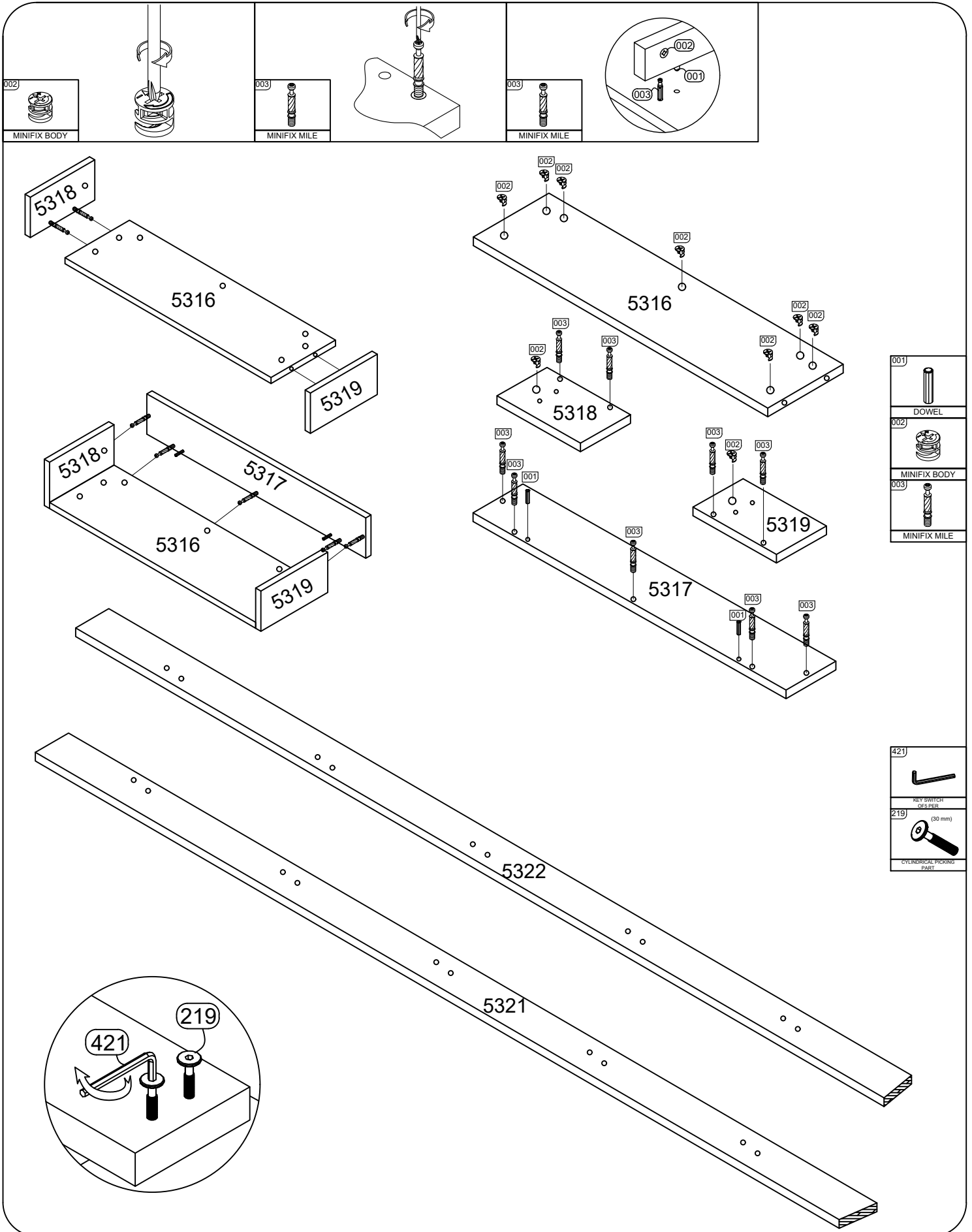

ONLY BOOKSHELF

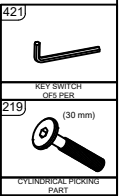
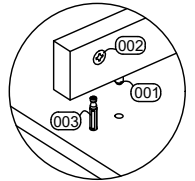
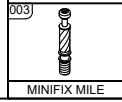
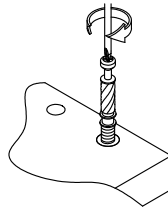
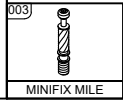
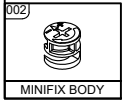
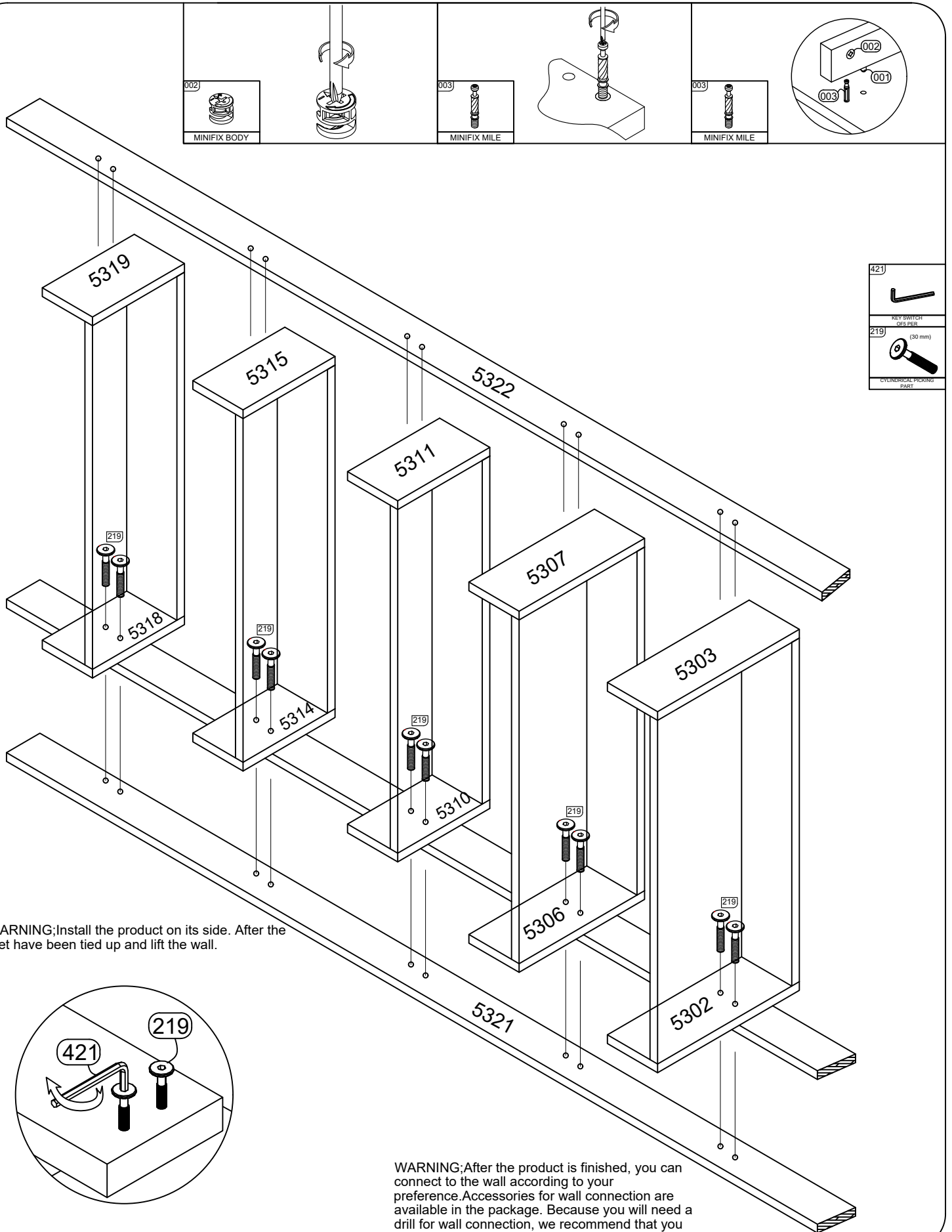

WARNING; Install the product on its side. After the feet have been tied up and lift the wall.

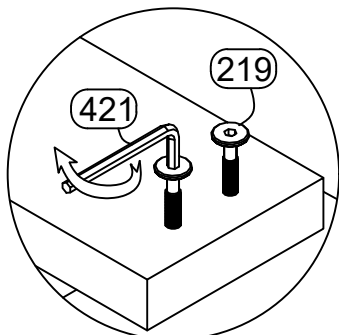

WARNING; After the product is finished, you can connect to the wall according to your preference. Accessories for wall connection are available in the package. Because you will need a drill for wall connection, we recommend that you get support.