

# Kumo Shelf Unit

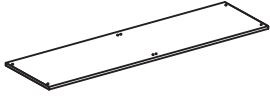

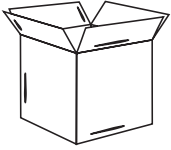

**A** x 2



**B** x 1

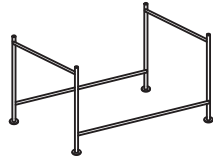

**C** x 2

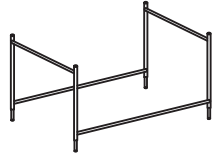

**D** x 6

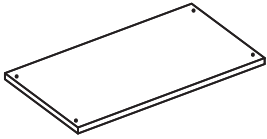

**E** x 2

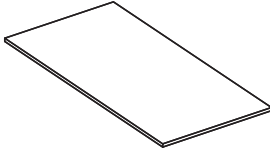

**F** x 2

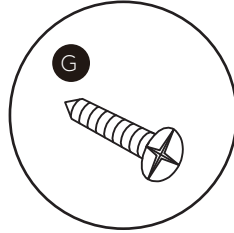

x 8

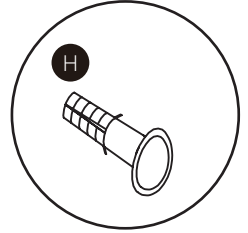

x 8

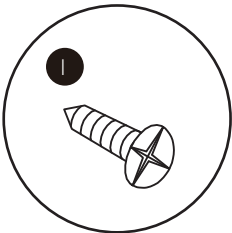

x 24

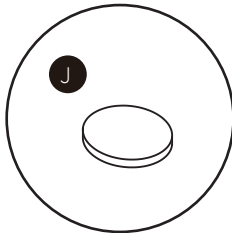

x 8

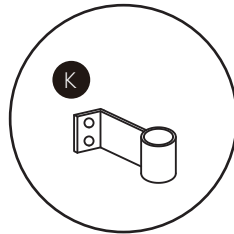

x 4

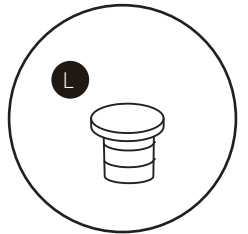

x 8

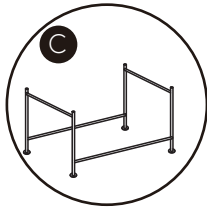

x 2

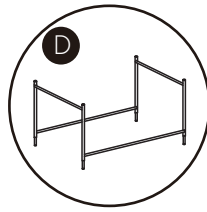

x 6

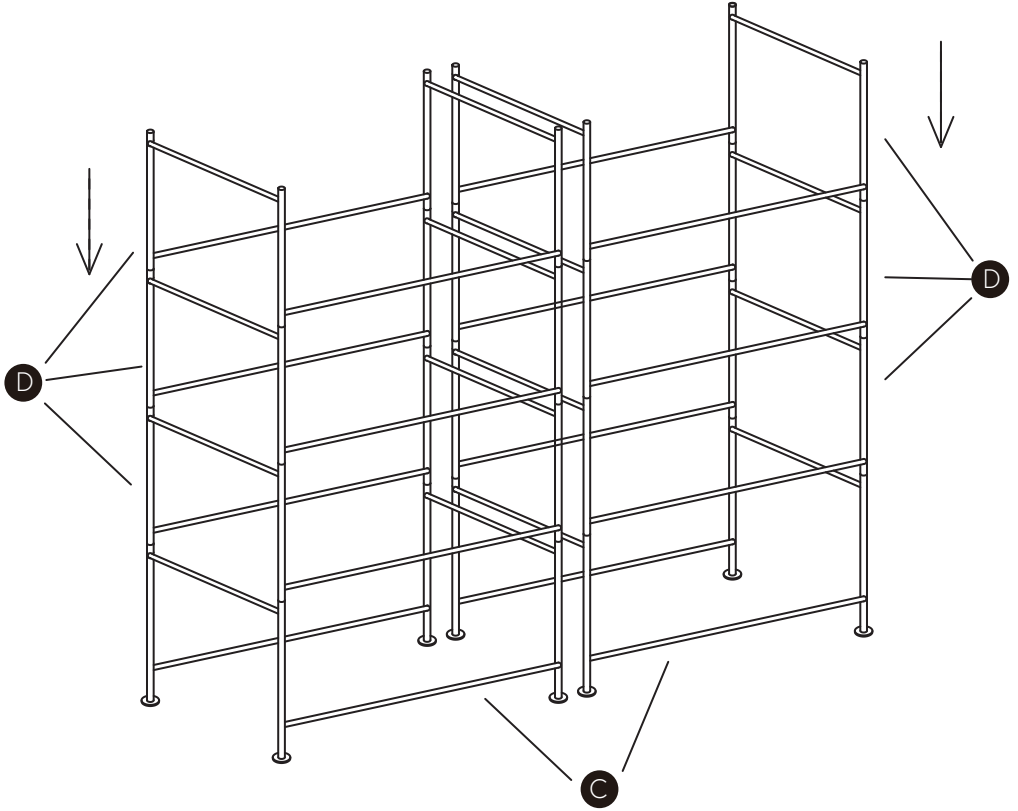



x 8

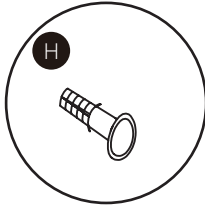

x 8

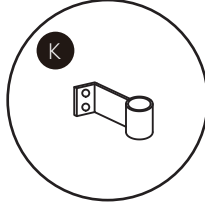

x 4

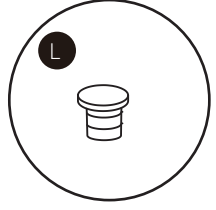

x 8

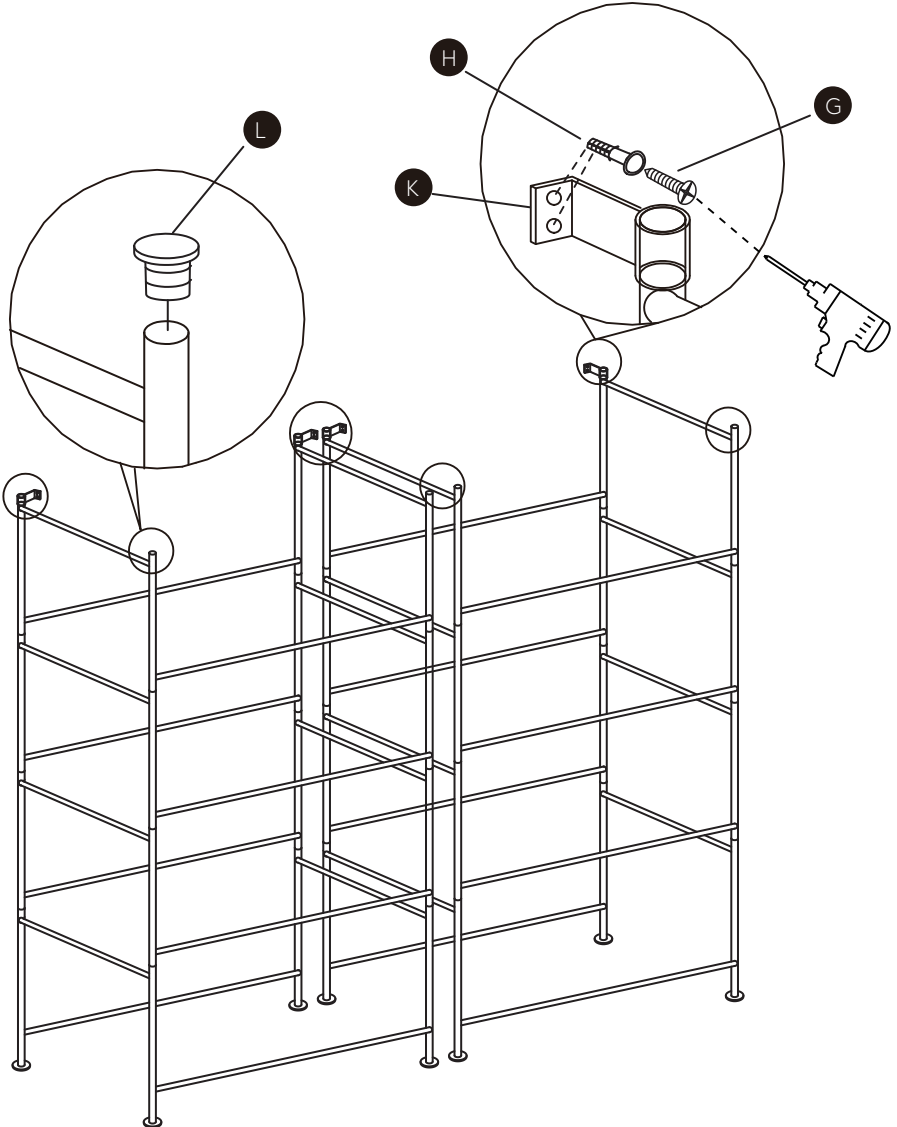

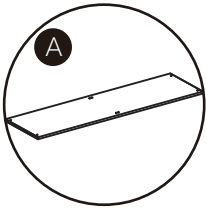

x 2

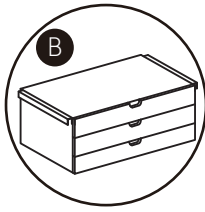

x 1

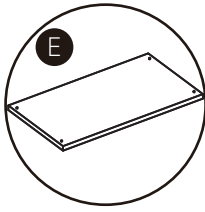

x 2

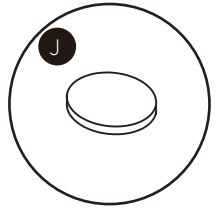

x 8

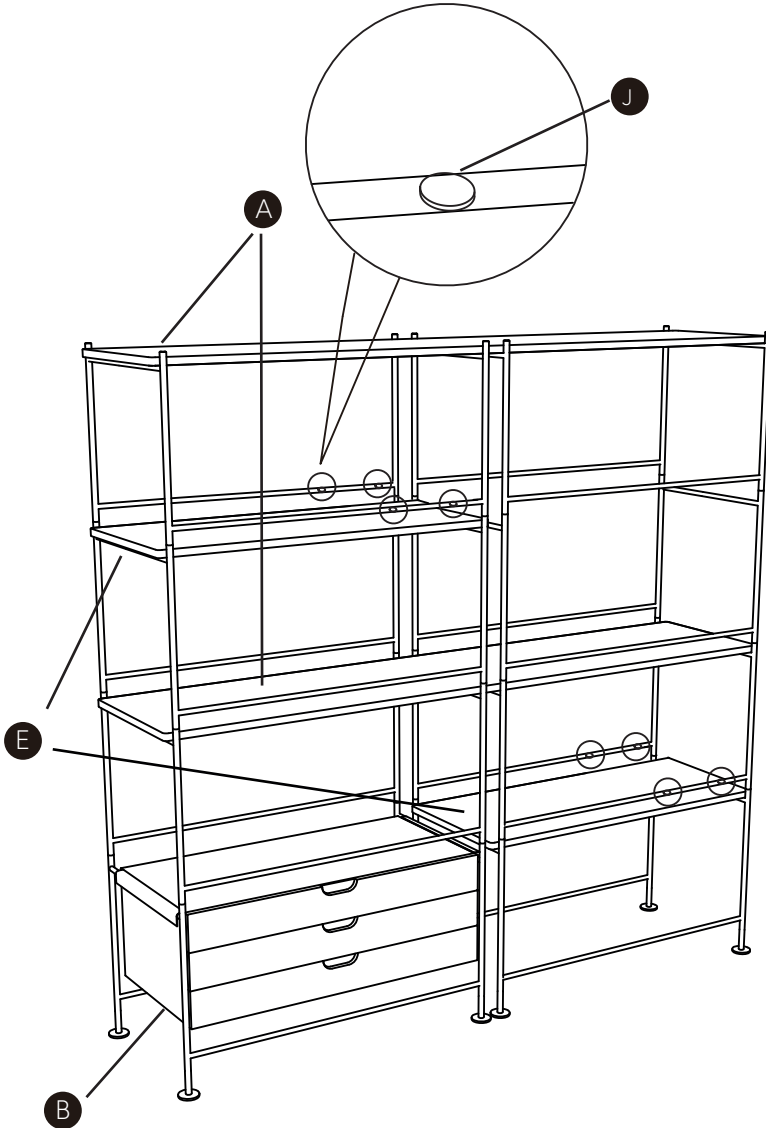

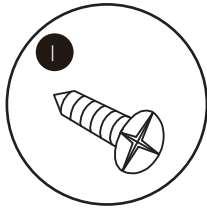

x 24

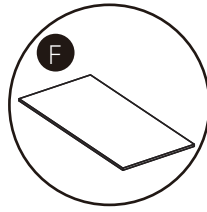

x 2

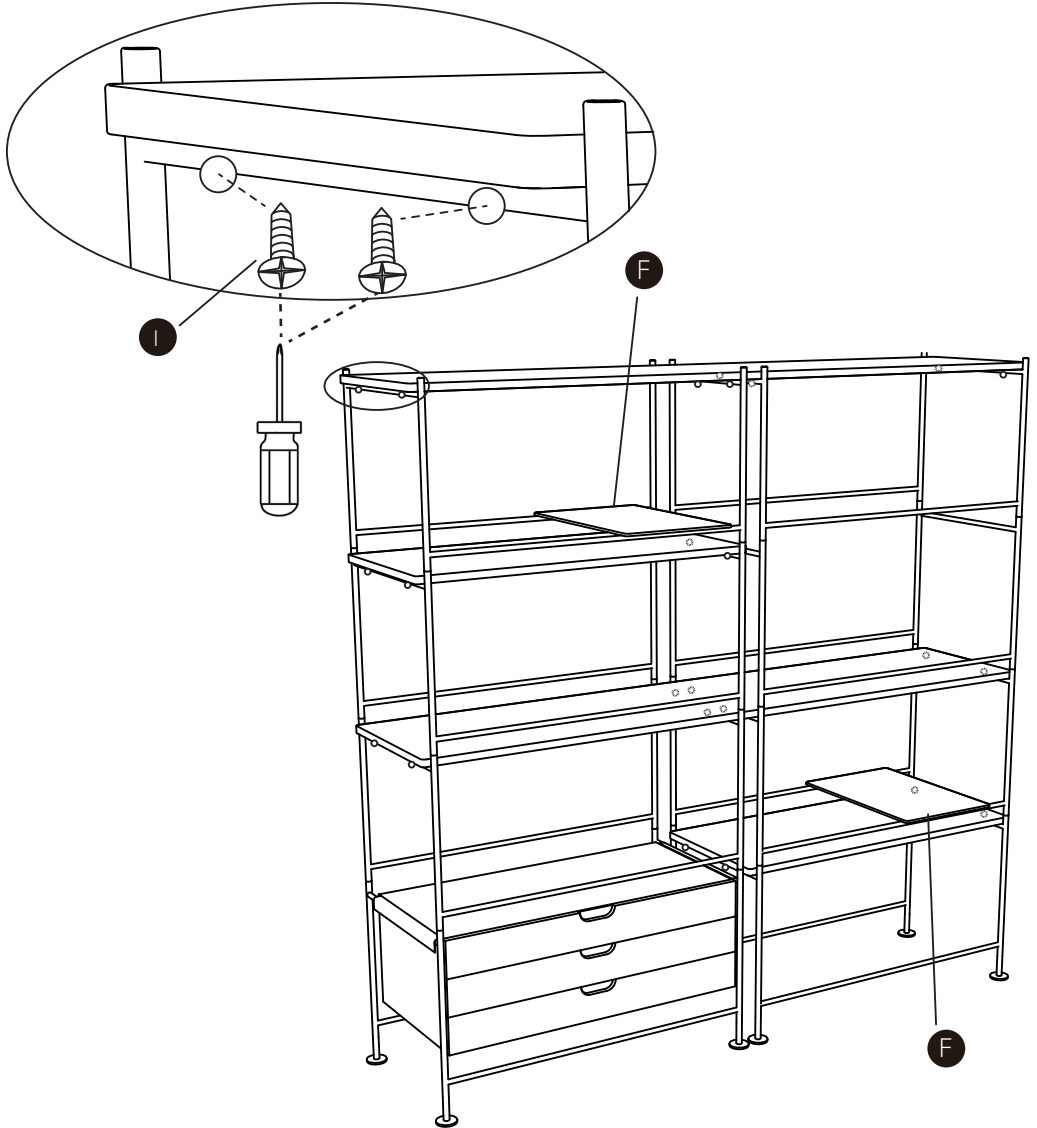

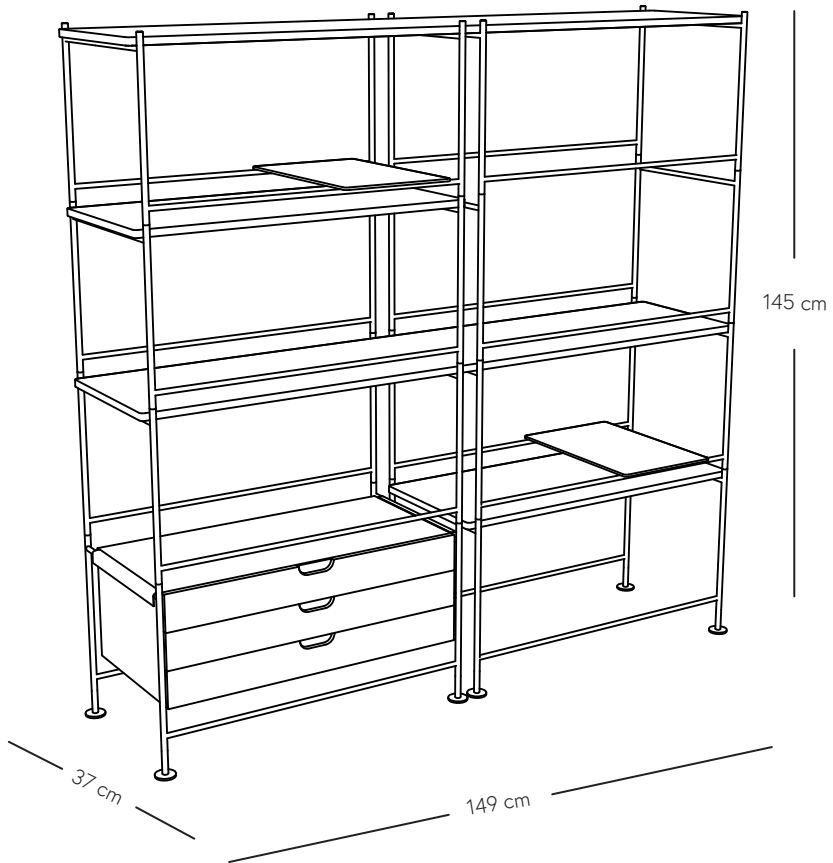



#myhubsch @hubschinterior

Hübsch  
DANISH HOME INTERIOR & DESIGN