

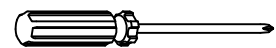

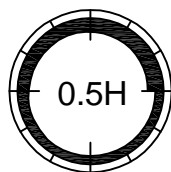

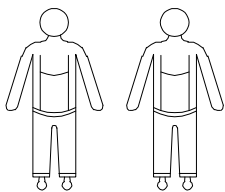

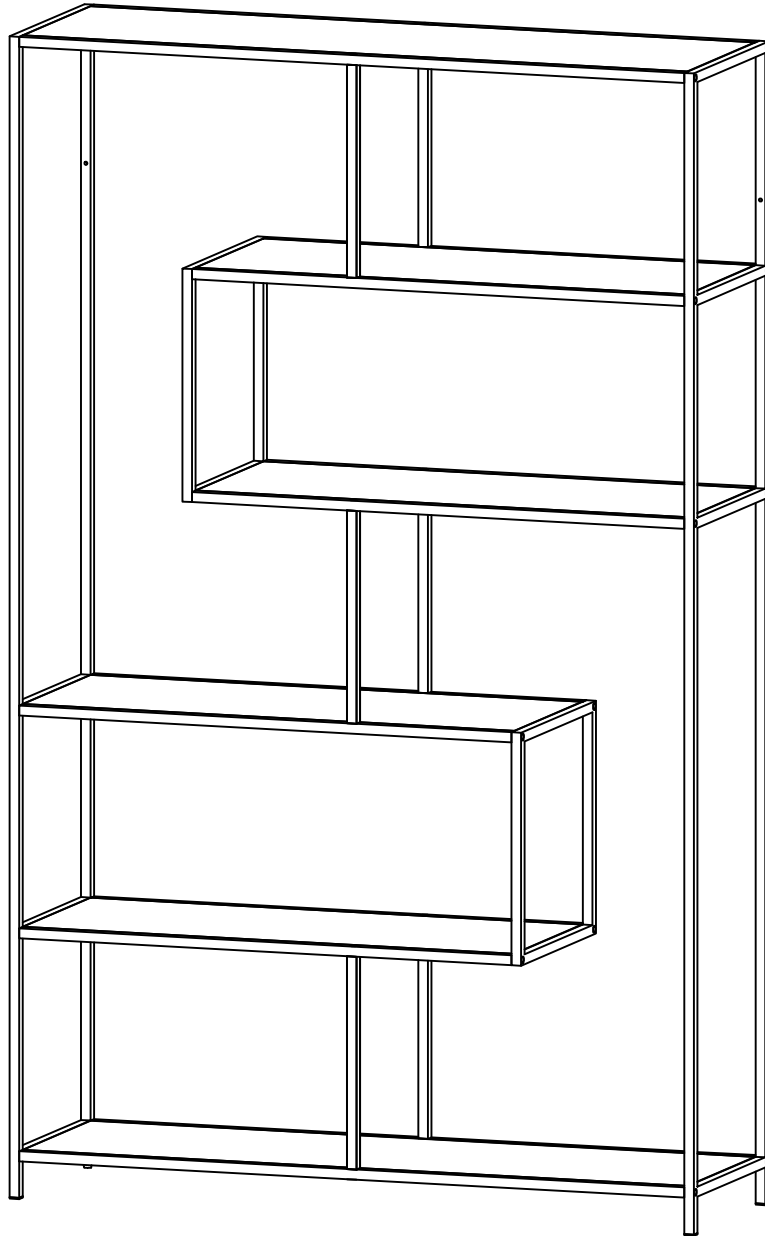

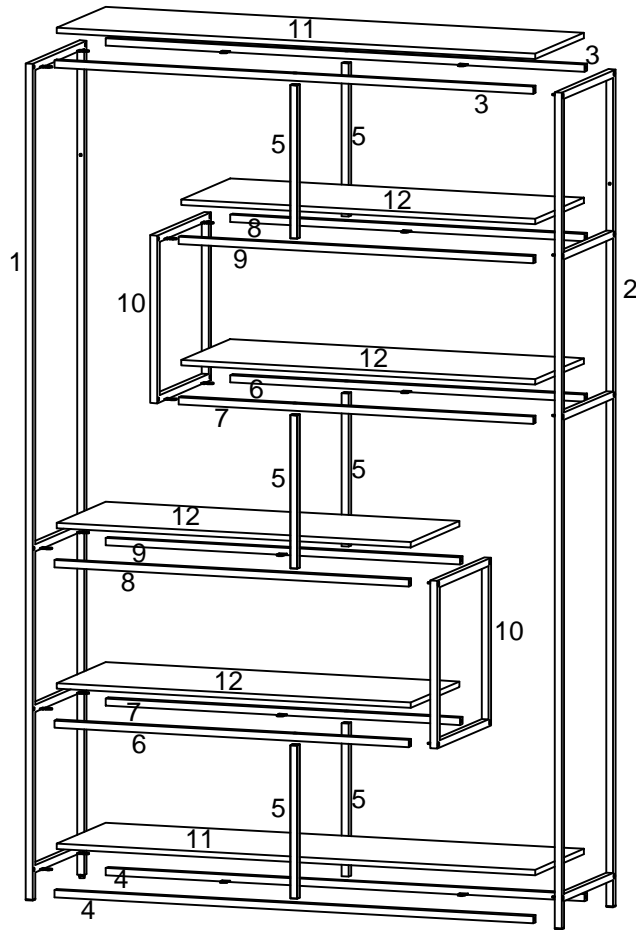





Seaford



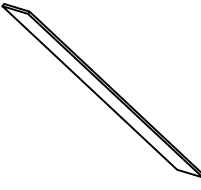

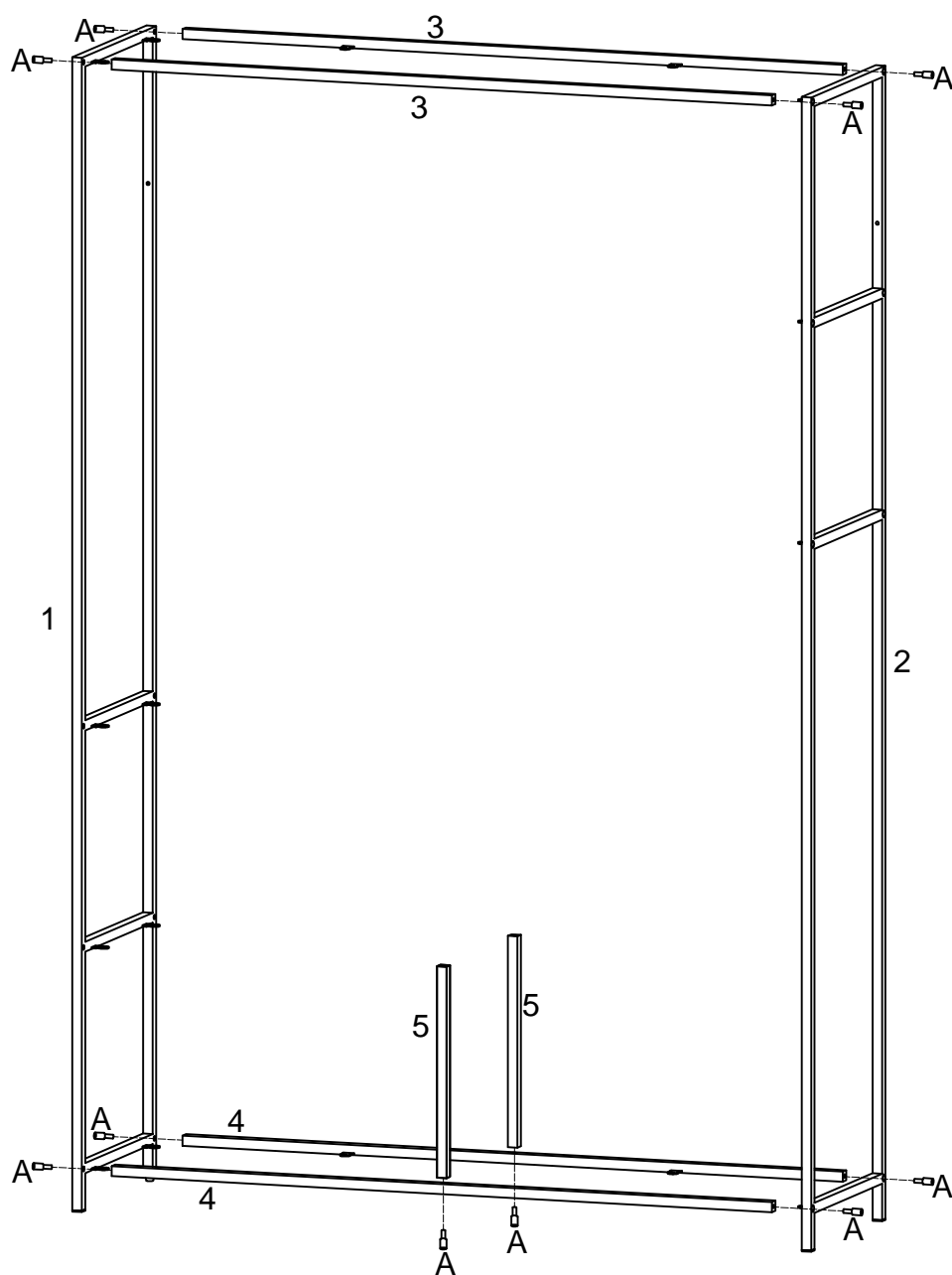
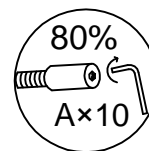

1  1PC	2  1PC	3  2PCS	4  2PCS	5  6PCS	6  2PCS
7  2PCS	8  2PCS	9  2PCS	10  2PCS	11  2PCS	12  4PCS
A M6×15mm  36PCS	B M4×10mm  40PCS	C 4mm  1PC			



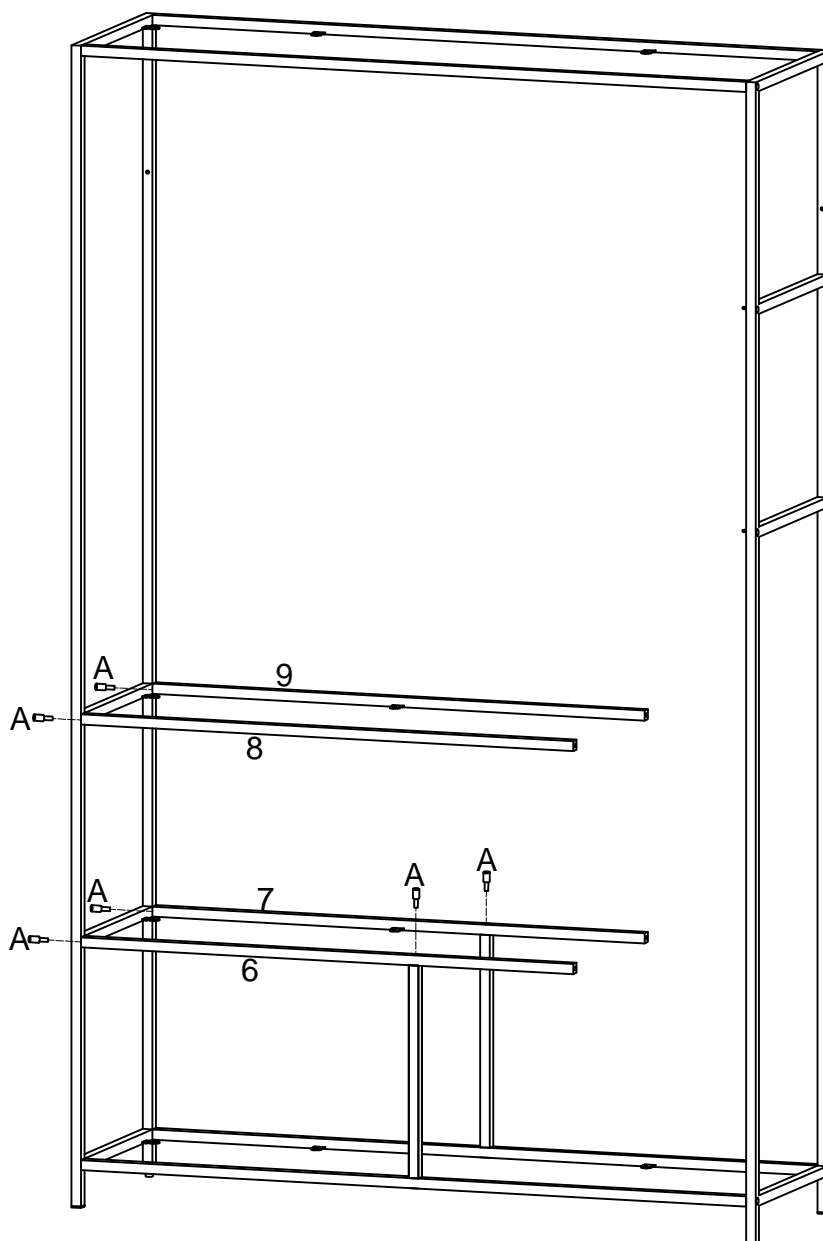
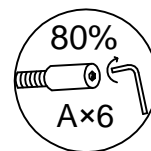

A M6×15mm 10PCS	C 4mm 1PC
----------------------------------	----------------------------



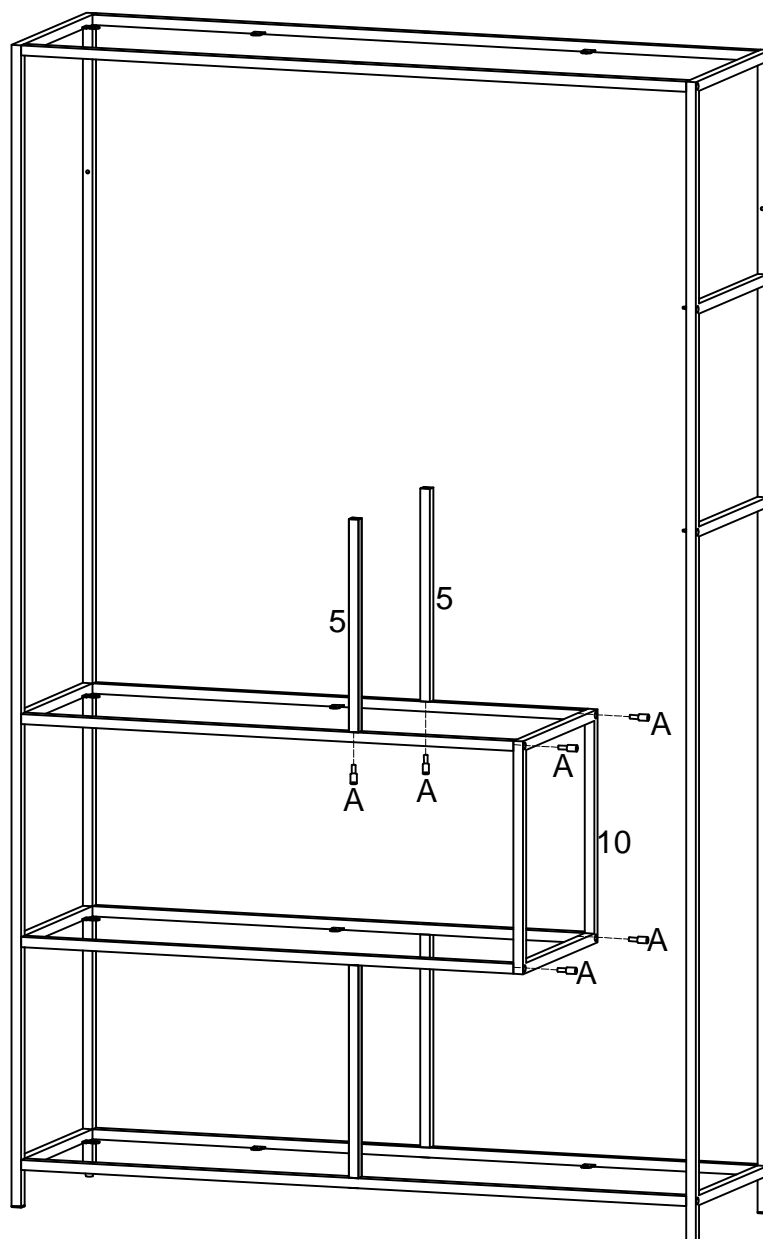
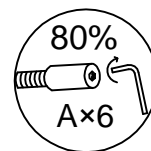

A M6×15mm  6PCS	C 4mm  1PC
--	---



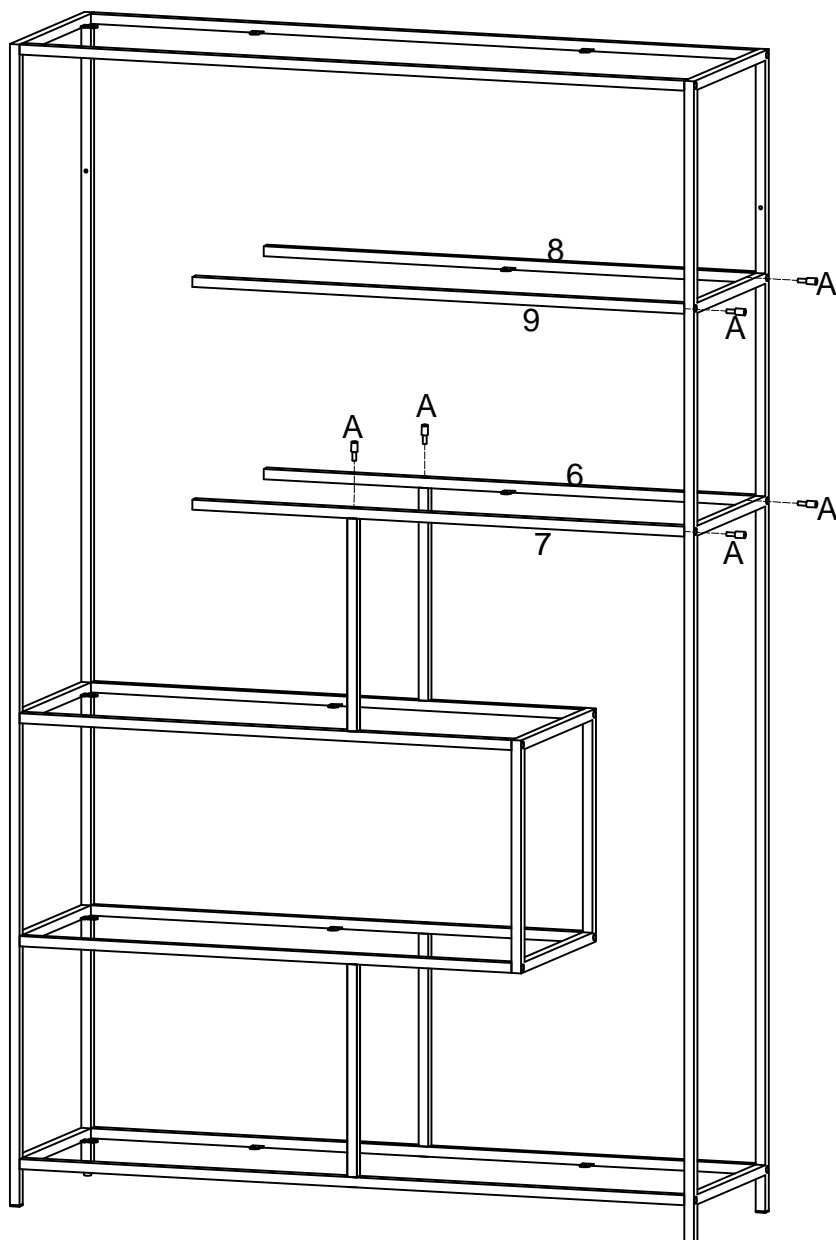
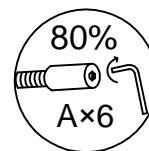

A M6×15mm  6PCS	C 4mm  1PC
--	---

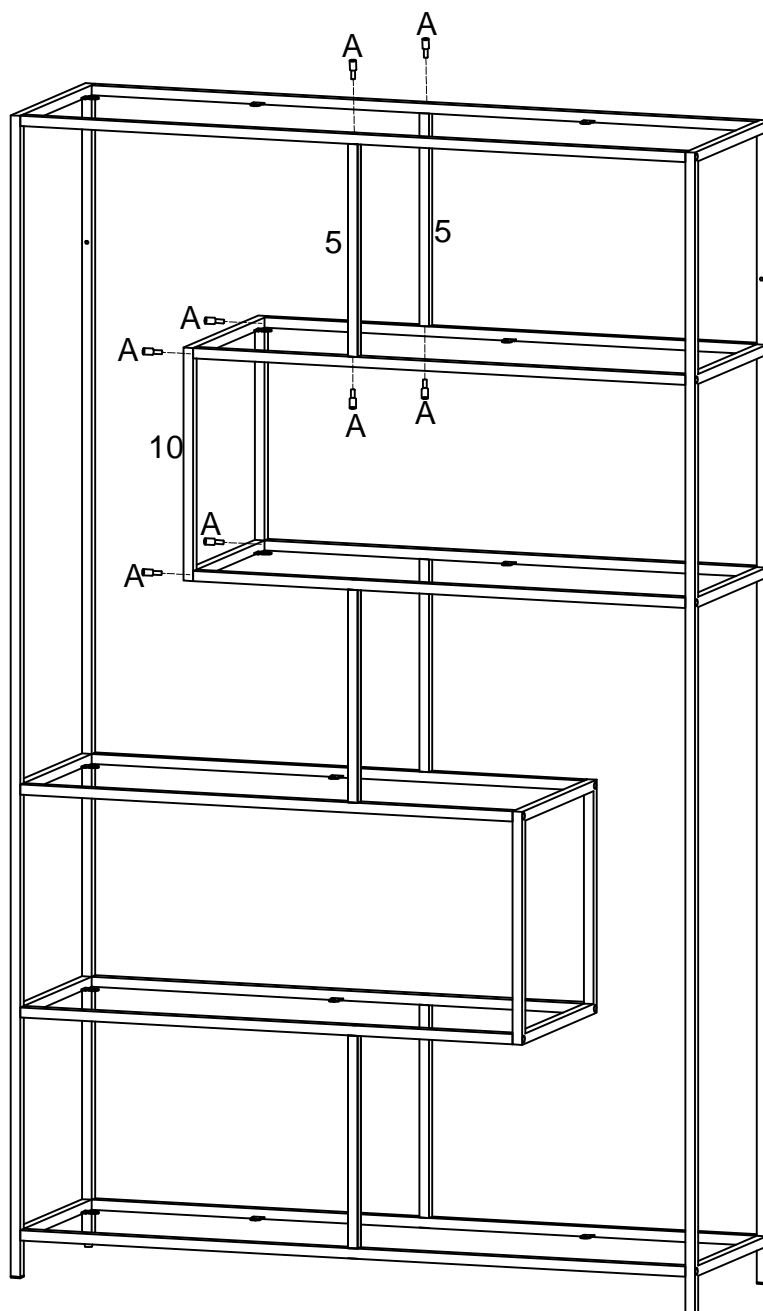
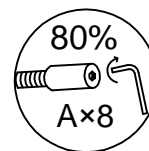

A M6×15mm  6PCS	C 4mm  1PC
--	---



A M6×15mm  8PCS	C 4mm  1PC
--	---

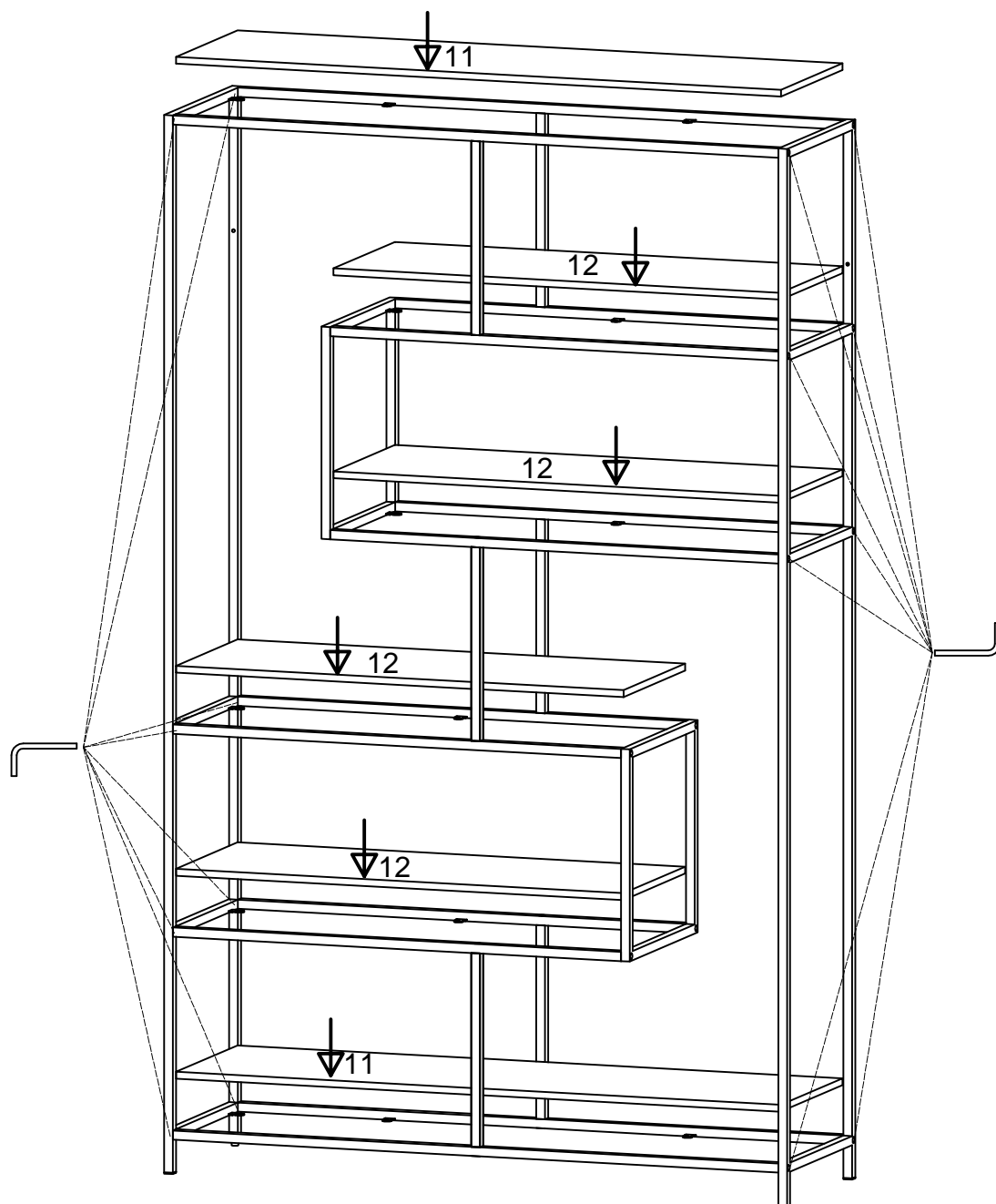
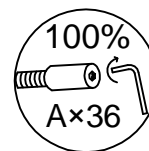

! XX=YY

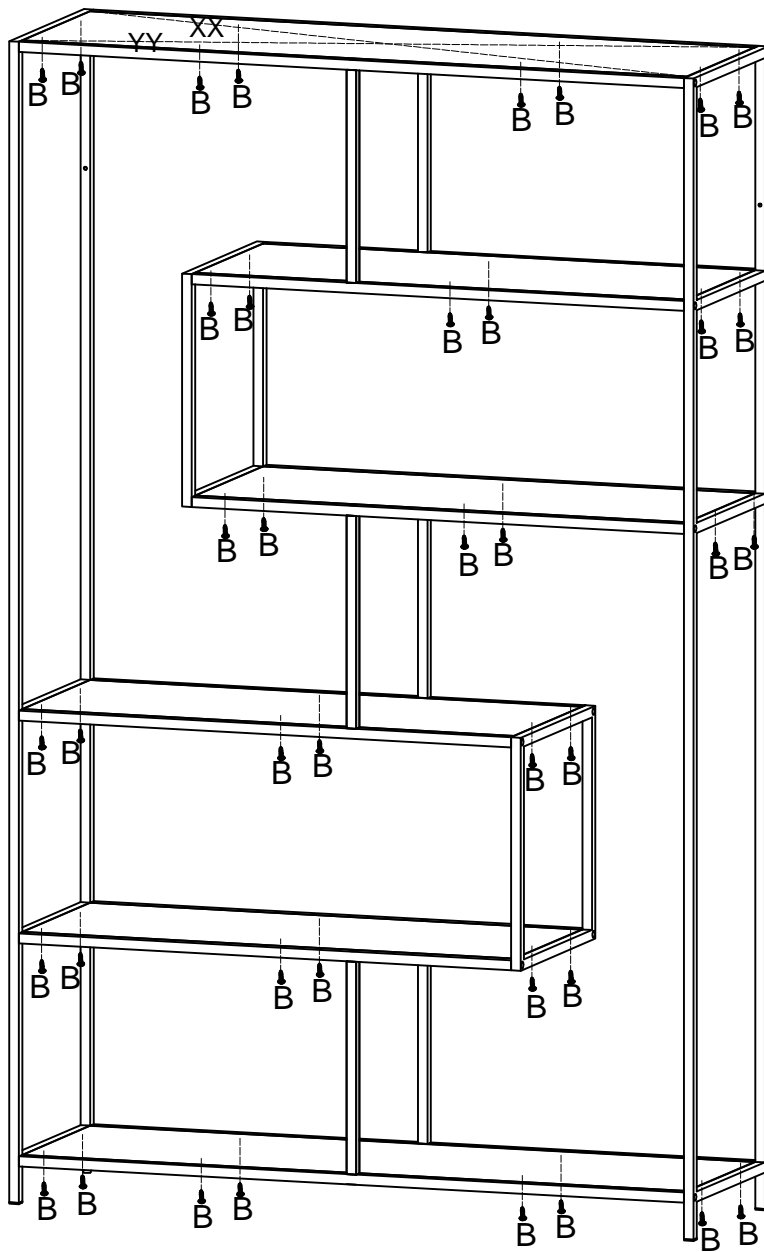
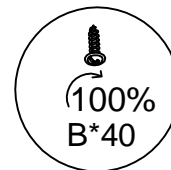

B
M4×10mm

40PCS

